

SYNTAX & MORPHOLOGY

DR. ABDULLAH AL-MULHIM

Om Yazar 1920

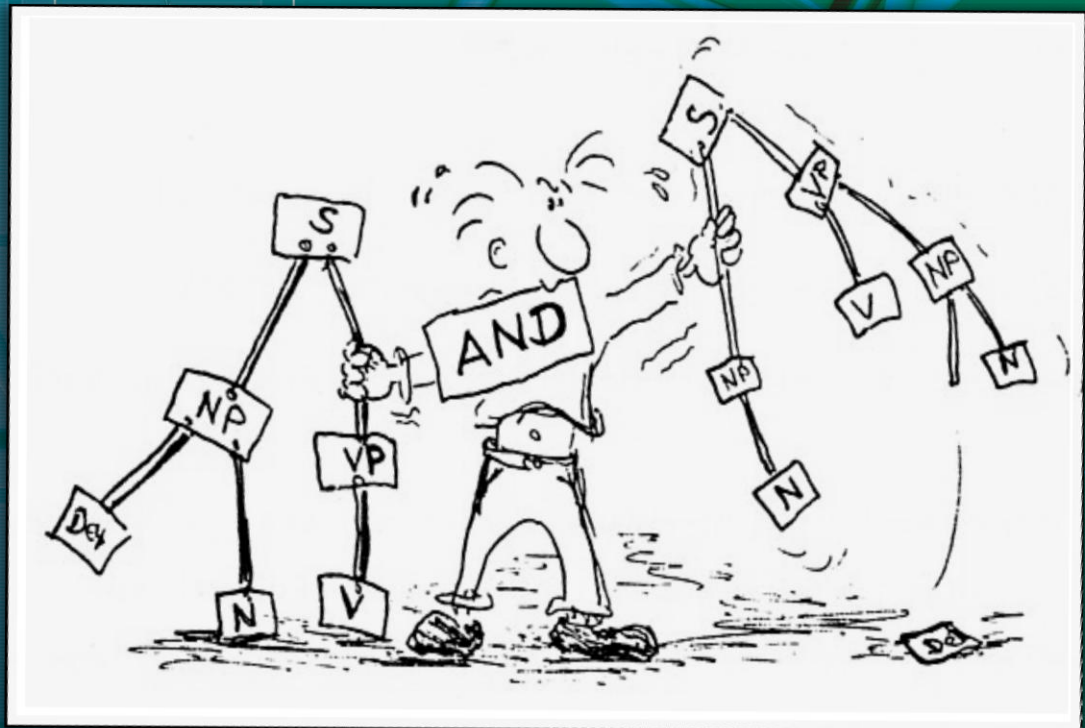

Definitions

Syntax:

the description of how words, phrases, and clauses are constructed and combined in a language.

Morphology:

the part of grammar explaining how morphemes are put together to construct words.

Grammar:

the analysis of the structure of phrases and sentences.

Morphemes:

are parts of words, i.e. stems, prefixes, and suffixes. For example, un + friend + ly contains three morphemes: a prefix un, a stem friend, and a suffix ly.

**** The part of grammar dealing with different grammatical units (words, phrases, clauses, and sentences) is known as Syntax.

*** The part of grammar dealing with morphemes is known as Morphology.

Types of grammatical units

We first need to identify the types of grammatical units, such as words and phrases, before describing the internal structure of these units, and how they combine to form larger units. Grammatical units are meaningful elements which combine with each other in a structural pattern. Essentially, grammar is the system which organizes and controls these form-meaning relationship.

→ **The types of grammatical units can be graded according to size of units.....example:**

*** If I wash up all this stuff somebody else can dry it.
(Sentence - clauses - phrases - words - morphemes)

Types of grammatical units

→ A **clause** consists of one or more phrases.

- A **phrase** consists of one or more words.
- A **word** consists of one or more morphemes.
- Grammatical units are described in terms of four factors: their structure, their syntactic role, their meaning, and the way they are used in discourse.

A- Structure:

units can be described in terms of their internal structure: e.g. words in terms of bases and affixes, phrases in terms of heads and modifiers, and clauses in terms of clause elements.

B- Role:

units can be described in terms of their syntactic role (subject, object...etc.) Example, In November, Susie won those tickets.

C- Meaning:

units can be described in terms of meaning. For example, adverbs (a class of words) can express information about time, place, and manner.

D- Use (discourse function):

units can be described in terms of how they behave in discourse (register and frequency).

Introduction to “words”

- “**Words**” are generally considered to be the basic elements of language. They clearly show up in writing , and they are the items defined in dictionaries. Yet the definition of ‘word’ is not simple.

→ Different senses of the word ‘word’:

- A- Orthographic words.
- B- Grammatical words.
- C- Lexemes.

→ Three major families of words

- A- Lexical words.
- B- Function words.
- C- Inserts.

Introduction to “words”

A. Lexical words:

Lexical words are the main carriers of information in a text or a speech act.

- They can be subdivided into the following parts of speech: (nouns, lexical verbs, adjectives, and adverbs).
- Lexical words are the most numerous, and their number are growing all the time (**open classes**).
- They often have a complex internal structure and can be composed of several parts: e.g. unfriendliness = un + friend + li + ness.
- Lexical words can be the heads of phrases: e.g. the noun completion is the head of the noun phrase (the completion of the task).

- They are generally the words that stressed most in speech.
- They are generally the words that remain if a sentence is compressed in a newspaper headline: e.g. Elderly care crisis warning.

B. Function words:

- Function words can be categorized in terms of parts of speech such as prepositions, coordinators, auxiliary verbs, and pronouns.
- They usually indicate meaning relationships and help us interpret units containing lexical words, by showing how the units are related to each other.
- Function words belong to **(closed classes)**, which have a very limited and fixed membership. For example, English has only four coordinators: and, or, but, and (rarely) nor.
- Individual function words tend to occur frequently, and in almost any type of text.

C. Inserts:

- Inserts are found mainly in spoken language..
- Inserts do not form an integral part of the a syntactic structure, but tend to inserted freely in a text.
- They are often marked off by a break in intonation in speech, or by a punctuation mark in writing: e.g. Well, we made it.
- They generally carry emotional and discourse meanings, such as oh, ah, wow, used to express a speaker's emotional response to a situation, or yeah, no, okay, used to signal a response to what has just been said.
- Inserts are generally simple in form, though they often have an atypical pronunciation (e.g. hm, uh-huh, ugh, yeah).

*** Closed and open classes

- Closed class contains a limited number of members, and new members cannot be easily added. For example, it is not easy to create a new coordinator or a new pronoun.....those word classes have a fairly fixed set of members.
- The membership of open classes is indefinitely large, and can be readily extended by users of the language. Lexical classes such as nouns and adjectives are open class. For example, we can easily form new nouns with **the suffix -ee (retiree)**, **adjectives with -ish (yellowish)**, **verbs with -ize (periodize)**, and **adverbs with -wise (fanwise)**.

*** The structure of words: morphology:

- Lexical words can consist of a single morpheme (a stem, such as go, book, cat), or they can have a more complex structure created by **a process of inflection, derivation or compounding**.

A- Inflection:

Lexical words can take inflectional suffixes to signal meanings and roles which are important to their word class, such as 'plural' in the case of nouns, and 'past tense' in the case of verbs. Examples.....

SYNTAX & MORPHOLOGY

- * **Nouns** boy plural (boys), genitive (boy's, boys')
- * **Verbs** live, write S.P.T (lives, write), P.T (lived, wrote), ing- participle (living, writing)

- * **Adjectives** dark comparative (darker), superlative (darkest)
- * **Adverbs** soon comparative (sooner), superlative (soonest)

B- Derivation:

- Derivation, like inflection, usually involve adding an affix, i.e. a morpheme attached to the beginning of a word (a **prefix**) or to the end of a word (a **suffix**). However, this process is different from inflection because inflection does not change the identity of a word(it remains the same lexeme), while derivation creates new nouns, adjectives, verbs, and adverbs. Derivation changes the meaning or word class (parts of speech) of a word, and often both, and in effect creates a new base form for the word:
 - Prefixes: **ex** + president, **un** + kind, **re** + read, **a** + broad
 - Suffix: boy + **hood**, central + **ize**, green + **ish**, exact + **ly**
- Words can be built up using a number of different prefixes and suffixes, and can thus contain several morphemes:
 - industri + **al**, industri + **al** + ize, industri + **al** + **iz** + **ation**

C- Compounding:

- Inflection and derivation result in complex words, with a stem plus one or more affixes. Another form of derivation is compounding, which also leads to more complex words. Words that are compounds contain more than one stem. Examples are:
 - noun + noun: chair + man, girl + friend
 - verb + noun: cook + book, guess + work
 - adjectives + nouns: blue + bird, flat + fish
 - noun + adjective: head + long, water + tight

2nd lecture

Lexical word classes

Lexical Words

There are four main classes of lexical words: nouns, lexical verbs, adjectives, and adverbs. To decide what class a word belongs to, it is useful to apply tests of three kinds:

1. Morphological: what forms does a word have (e.g. in terms of stems and affixes)?

2. Syntactic: what syntactic roles does a word play in phrases or other higher units?
3. Semantic: what type(s) of meaning does a word convey?

Nouns

- Words such as book, girl, gold, information are common nouns. Words such as Sarah, Oslo, Microsoft (names) are proper nouns. Nouns have the following characteristics:

A- Morphological:

Nouns have inflectional suffixes for plural numbers, and for genitive case: one book---
- two books; Sarah's book. Many nouns, however, are uncountable, and cannot have a plural form (e.g. gold, information). Nouns quite often contain more than one morpheme (e.g. compound nouns (clothes+line) - nouns with derivational suffixes (e.g. sing+ er, friend+ship, bright+ness)

B- Syntactic:

Nouns can occur as the head of a noun phrase (a new *book* about the cold war) (the ugliest *person* you've ever seen). As these examples show, common nouns such as book and person can be modified by many kinds of words both before and after them. Proper nouns like Sarah, on the other hand, rarely have any modifiers.

C- Semantic:

Nouns commonly refer to concrete, physical entities (people, objects, substances) : e.g. book, friend, iron. They can also denote abstract entities, such as qualities and states: e.g. freedom, wish, friendship.

Lexical Verbs

Words such as admit, build, choose, write are lexical verbs. They are distinct from Auxiliary verbs like can and will, which we treat as function words. The primary verbs be, have and do (the most common verbs in English) occur as both lexical verbs and auxiliaries. Lexical verbs are identified as follows:

A- Morphological:

Lexical verbs have different forms signaling tense (present & past), aspect (perfect & progressive), and voice (active & passive). Verb lexemes quite often have a complex form with more than one morpheme. The following are examples of multi-word verbs and derived verbs: bring up, rely on, look forward to, itemize, soften.

B- Syntactic :

Lexical verbs most frequently occur on their own, as a single-word verb phrase acting as the central part of the clause (He *writes* page after page about tiny details). They also occur in the final or main verb position of verb phrase (has *written* a letter) (will be *writing* tomorrow).

C- Semantic :

Lexical verbs denote actions, processes, and states of affairs that happen or exist in time. They also define the role of human and non-human participants in such actions,

SYNTAX & MORPHOLOGY

processes, or states (You ate Chinese food). In this example, *ate* expresses the action performed by *you* on the Chinese food.

Adjectives

Words such as dark, heavy, eager, and guilty are adjectives. Adjectives are identified as follows:

A- Morphological:

Many adjectives can take inflectional suffixes *-er* (comparative), and *-est* (superlative): dark ---- darker ---- darkest. Adjectives can be complex in morphology (derived adjectives e.g. acceptable, forgetful, influential) (compound adjectives e.g. color-blind, home-made, ice-cold).

B- Syntactic:

Adjectives can occur as the head of an adjective phrase: (very dark) (eager to help) (guilty of a serious crime). Adjectives and adjective phrases are most commonly used as modifiers preceding the head of a noun phrase or predicative following the verb in clauses (modifiers e.g. Tomorrow could be a *sunny* day) (predicative e.g. it is *nice* and *warm* in here. It's *sunny*).

C- Semantic:

Adjectives describe the qualities of people, things, and abstractions: a *heavy* box, he is *guilty*, the situation is *serious*. Many adjectives are gradable. That is, they can be compared and modified for the degree or level of the quality: heavier, very heavy, extremely serious.

Adverbs

Words such as now, there, usually, and finally are adverbs. Adverbs are identified as follows:

A- Morphological:

Many adverbs are formed from adjectives by adding the suffix *-ly*: clearly, eagerly. Others have no such ending: however, just. A few adverbs allow comparative and superlative forms like those for adjectives: soon --- sooner --- soonest; fast --- faster --- fastest.

B- Syntactic:

Adverbs occur as head of adverb phrases: (very *noisily*) (more *slowly* than I had expected). Adverbs, with or without their own modifiers, are often used as modifiers of an adjective or another adverb: (really old) (very soon). Otherwise, they can act as adverbials in the clause (I'll see you *soon again*).

C- Semantic:

As modifiers, adverbs most often express the degree of a following adjective or adverb:

(totally wrong) (right now). As elements of clauses (adverbials), adverbs and adverb phrases have a wide range of meanings:

- They can modify an action, process, or state, by expressing such notions as time, place, and manner. (So I learner German quite *quickly*) (She was *here earlier today*).
- They can convey the speaker's or writer's attitude towards the information in the rest of the clause. (*Surely* that child is not mine!).

- They can express a connection with what was said earlier. (It must be beautiful, *though*).

Comparing lexica word classes in use

- Nouns and verbs are clearly the most common types of words overall.
- Conversation has a high density of verbs, unlike informative writing such as news and academic prose, which has a high density of nouns.
- Adjectives are linked to nouns, because they most frequently modify nouns. So informative writing, which has the highest density of nouns, also has the highest density of adjectives.
- Adverbs, on the other hand, are linked to verbs. They typically describe circumstances relating to actions, processes, and states that are denoted by verbs. So conversation and fiction writing, which have the highest density of verbs, also have the highest density of adverbs.

3rd lecture

Function Word Classes

Function Words

Function words can also be categorized in different classes: determiners, pronouns, auxiliary verbs, prepositions, adverbial particles, coordinators, and subordinators. To distinguish these classes briefly, we will look at their semantic function and syntactic role, list their main forms, and consider their subclasses.

1- Determiners:

Determiners normally precedes nouns, and are used to help clarify the meaning of the noun. The most important are the following:

The definite article 'the' indicates that the referent is assumed to be known by the speaker and the person being spoken to (addressee).

- The indefinite article 'a' or 'an' makes it clear that the referent is one member of a class (a book).
- Demonstrative determiners indicate that the referent are 'near to' or 'away from' the speaker's immediate context (this book, that book)

Function Word Classes

- Possessive determiners: tell us who or what the noun belongs to (my book, your book, her book...etc).
- Quantifiers: specify how many or how much of the noun there is (every book, some books).
- There are also determiners- like uses of wh-words and numerals.

2- Pronouns:

pronouns fill the position of a noun or a whole noun phrase. The reference of a pronoun is usually made clear by its contexts. There are eight major classes of pronouns:

- Personal pronouns: refer to the speaker, the addressee(s), and other entities (I won't tell you how it ended). Personal pronouns are used far more frequently than the other classes of pronouns.
- Demonstrative pronouns: refer to entities which are 'near to' v. 'away from' the speaker's context, like demonstrative determiners. (This is Bay city) (I like those)
- Reflexive pronouns: refer back to a previous noun phrase, usually the subject of the clause. (I taught myself) (She never understood herself).
- Reciprocal pronouns: like reflexive pronouns, refer to a previous noun phrase, but indicate that there is a mutual relationship. (Yeah they know each other pretty well).
- Possessive pronouns: (such as mine, yours, his) are closely related to possessive determiners (my, your, his, ..etc), and usually imply a missing noun head. (Is this yours, or mine) (Ours is better than theirs). The possessive pronouns include the meaning of a head noun (yours might refer back to your book or your car).
- Indefinite pronouns: have a broad, indefinite meaning. Some of them are compound words consisting of quantifiers + general noun (everything, nobody, someone). Others consist of a quantifier alone (all, some, many)
- Relative pronouns (who, whom, which, that) introduce a relative clause. (I had more friends *that* were boys) (He's the guy *who* told me about this).
- Interrogative pronouns: ask questions about unknown entities. (*what* did he say) (I just wonder *who* it was).
- Most of relative and interrogative pronouns (e.g. who, which, what) belong to the class of *wh-* words.

3- Auxiliary Verbs:

There are two kinds of auxiliary verbs: Primary Auxiliary & Modal Auxiliary. Both are 'Auxiliary Verbs' in the sense of that they are added to a main verb to help build verb phrases. Auxiliary verbs precede the main or lexical verb in a verb phrase: (will arrive, has arrived, is arriving, may be arriving). Some common auxiliaries have contracted forms ----'s, 're, ---'ve, --'d, --'ll, used particularly in speech.

- **Primary Auxiliaries:** There are three auxiliaries: *be*, *have*, and *do*. They have inflections like lexical verbs, but normally unstressed. The same verbs *be*, *have*, and *do* can also act as main verbs. In various ways, **the primary auxiliaries show how the main verb is to be understood:**
 - The auxiliary *have* is used to form perfect aspect (e.g. I've done that once).
 - The auxiliary *be* is used for the progressive aspect or 'continuous' aspect(e.g. She *was* thinking about me).
 - The auxiliary *do* is used in negative statements and in questions (known as do insertion (e.g. *Did* he sell it?) (This *doesn't* make sense).

- **Modal Auxiliaries:** There are nine modal auxiliary verbs. As their name suggests, they are largely concerned with expressing ‘modality’, such as possibility, necessity, prediction, and volition. **The modals are:** will, can, shall, may, must, would, could, should, might. In practice the modals can be regarded as invariable function words, with no inflections such as -ing and -ed. The modal will and would have contracted forms (‘ll & ‘d), and most modals have a contracted negative form ending in (n’t), such as wouldn’t. Modals occur as the first verb in a clause, and are followed by the base form of another verb, usually the main verb. (I *can* live here quietly) (They *would* have a different view).

4- **Prepositions:**

are linking words that introduce prepositional phrases. The prepositional complement following a preposition is generally a noun phrase, so prepositions can also be seen as linking words that connect other structures with noun phrases. (Eleven fifty with the tip) (And she is in a new situation) (that picture of mother) (She’s still on the phone).

- Most prepositions are short, invariable forms e.g. about, after, around, as, at by, down, for, from, into, like, of, off, on, round, since, than, to towards, with, without. In the following examples, the preposition is in bold, and the prepositional phrase it introduces is enclosed in []. The noun phrase functioning as prepositional complement is underlined. He’ll go [**with** one of the kids] . Prepositions can be linked to a preceding verb as ‘rely on’. (you can’t, you can’t *rely on* any of that information).
- Complex prepositions consist of multi-word units (e.g. such as, as for, except for, apart from, because of, instead of, out of, regardless of, according to, due to, owing to, by means of, in spite of, in addition to, with regard to, as far as, as well as).

5- **Adverbial Particles:**

- are a small group of words with a core meaning of motion. The most important are: about, across, along with, around, aside*, away*, back*, by, down, forth*, home*, in, off, on, out, over, past, round, through, under, up.
- All of these forms except those marked * can also be prepositions. Adverbial particles are closely linked to verbs. The generally follow verbs, and are closely bound to them in meaning: go away, come back, put (something) on, etc.
- They are used to build phrasal verbs, such as the following: (*Come on*, tell me about nick) (I *just broke* down in tears when I saw the letter) (Susan rarely *turned on* the television set). They are also used to build extended prepositional phrases, where a particle precedes the preposition. (We were going *back to the hotel* when it happened).

6- **Coordinators:**

There are two types of words traditionally called Conjunctions in English:

Coordinators and subordinators. Coordinators are used to indicate relationship between two units such as phrases or clauses. The main coordinators are: and, but, and or. In the following examples, the coordinated elements are marked [] (e.g. [Mother] **and** [I] saw it) ([I don’t want to speak too soon], **but** [I think I have been fairly consistent this season]) (Is this necessarily [good] **or** [bad]).

- Correlative coordinators (both X and Y) (not only X but also Y) (either X or Y) (neither X nor Y).

7- Subordinators:

are linking words that introduce clauses known as dependent clauses (clauses which cannot stand along without another clause, called the main clause: (You can hold her[*if* you want]). The subordinator shows the connection of meaning between the main clause and the subordinate clause. Subordinators fall into three major subclasses:

- The great majority of subordinators introduce adverbial clauses, adding details of time, place, reason, etc. to the main clause (e.g. after, as, because, if, since, although, while).
- Three subordinators introduce degree clauses: (as, than, that).
- Three subordinators introduce complement clauses: (if, that, whether).

8- Special Classes of Words:

A few classes of function words have special qualities: wh-words, existential there, the negator not, the infinitive marker to, and numerals.

4th lecture

Describing a Sentence

Describing a Sentence

- We humans are not the only species that engages in oral communication.
- Our language has an enormous range because it consists of parts that can be arranged in unlimited ways.
- Humans ability to arrange words in different ways allow us to produce a potentially infinite number of grammatical sentences, but because not all are grammatical, our grammar must consist of principles or rules for arranging them. Violations of the rules result in ungrammatical sentences.

Examples:

- No Monkeys have words.
- Monkeys have no words
- Have Monkeys no words?
- Have no Monkeys words?
- No Words have Monkeys.
- Have no words, Monkeys!
- * Words monkeys have no.

Discovering the Parts of Sentences

Example :

The monkey saw a leopard.

- If you were asked to divide the sentence into its parts, you would of course identify the five words that comprise it. But what if you are asked about larger units? Are there any groupings of words in the sentence that seem to “go together”?
- Your intuitions would probably lead you to identify *the monkey* and *a leopard* as groupings in this sense. They seem to belong together in a way that *monkey saw* or *saw a* clearly do not. Furthermore, *the monkey* and *a leopard* seem very similar, as if they are groupings of the same type. In fact we can substitute one for the other and still have a grammatical (although different) sentence:
- (*A leopard saw the monkey*). In contrast. If we switch *the monkey* with a different grouping as *saw a*, the result would be ungrammatical:
- (* *Saw a the monkey leopard*).

- # If we determine that sentences are constructed out of such groupings, we will have gained an important insight into the structure of the English language. From now on, we will call such groupings PHRASES. That is, we will consider a phrase to be one or more words that occur together in a sentence and that we recognize as somehow working together as a unit. Phrases can be said to function as CONSTITUENTS--- that is, as parts that make up or constitute sentences. All subparts of sentences can be called CONSTITUENTS, from individual words like *monkey* to phrases like *the monkey* to the entire sentence itself.

- Another test of the reality of a phrase like *the monkey* is whether other such phrases can be found that can substitute for it in a grammatical sentence.

Examples:

- The crocodile saw a leopard.
 - A leopard saw a leopard.
 - The wise, old, alert monkey saw a leopard.
 - Anita saw a leopard.
 - The man who had a scar above his right eye saw a leopard.
 - We saw a leopard.
- >>>>>>> Let's give this type of phrase a name.....we call it a noun phrase (NP).
- # Not every grouping of words is a noun phrase (NP).

Examples:

- Ate saw a leopard.
- Ate a banana saw a leopard.
- Very happy saw a leopard.
- Fearfully saw a leopard.
- Over the river and through the woods saw a leopard.
- According to our test procedure, none of the above examples seems to be a noun phrase (NP).

- In addition to the two noun phrases in our example (*The monkey saw a leopard*), also contains the word *saw*, which, according to our test, is not a noun phrase. By

SYNTAX & MORPHOLOGY

performing the same substitution test that we conducted on noun phrases, we can find many other words that could take the place of *saw* in the sentence: *angers*, *ticked*, *resembles*, *hypnotized*, to name a few. So *saw* belongs to another category of CONSTITUENTS; we will call it a verb (V).

- # Our analysis of our example (*The monkey saw a leopard*) has shown us that it consists of a noun phrase (*the monkey*) followed by a verb (*saw*) and then another noun phrase (*a leopard*). So we can infer that:
 $S \rightarrow NP + V + NP$
- We can analyze our example further. Two of the constituents appear to have constituents of their own, because the noun phrases each consist of two words. The words *the* and *a* can be interchanged (*A monkey saw the leopard*), and we will call them ARTICLES (Art). Likewise *monkey* and *leopard* belong to the category NOUN (N). We can infer:
 $NP \rightarrow Art + N$
- This tells us that the noun phrase (*the monkey*) consists of the article *the* followed by the noun *monkey*.
- # Finally, many people have the intuitive feeling that, just as *a leopard* is a constituent of the sentence (*The monkey saw a leopard*), so too is the longer phrase *saw a leopard*. That is, they sense that the sentence consists of two major parts, *the monkey* and *saw a leopard*. Or to put it in terms of the sentence's meaning, the sentence consists of (who-did-it?) part (*the monkey*) and a (did-what?) part (*saw a leopard*). Let us give the latter constituent the name VERB PHRASE (VP). We observe that it consists of a verb (*saw*) followed by a noun phrase (*a leopard*). Therefore, we can infer:
 $VP \rightarrow V + NP$
- Now, We can revise the rules:

$S \rightarrow NP + VP$
 $NP \rightarrow Art + N$
 $VP \rightarrow V + NP$

Labeled Brackets and Boxes

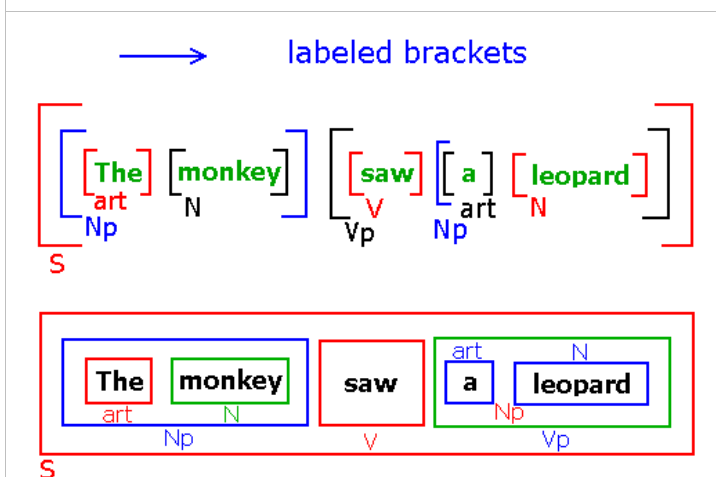

Tree Diagrams

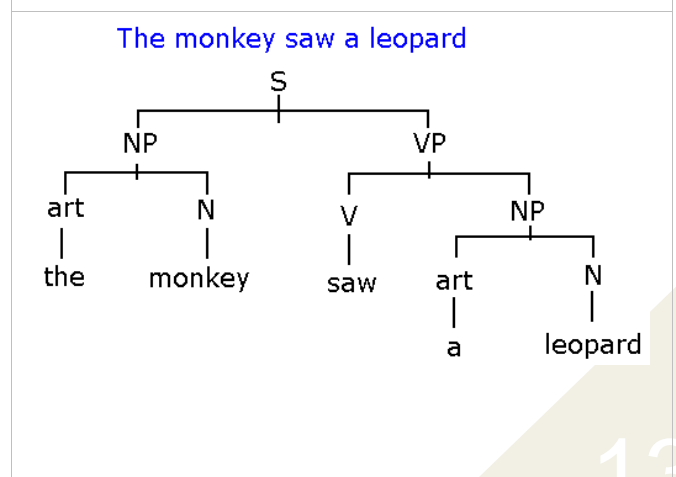

Tree Diagrams

A leopard saw a monkey

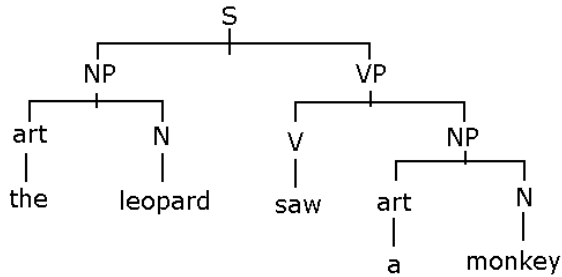

Exercises

- 1- Place labeled brackets around each of the constituents in the following sentence:
The soldier spied an enemy
- 2- Draw labeled boxes around the constituents in the following sentence:
An amateur won the championship
- 3- Draw a tree diagram of the following sentence:
A couple danced the tango

5th lecture

Nouns and Verbs

Proper & Common Nouns

- In traditional school of grammar, a noun is usually defined in terms of meaning: A noun is the name of a person, place or thing. We earlier described a noun phrase as an article-noun combination, but a little investigating will show us that not all noun phrases have the same constituents. In some cases, a single word is the noun phrase:
(Tarzan saw a leopard)
(Rover saw a leopard)
Therefore, our earlier RULE NP ----> Art N is inadequate because it does not describe all possible noun phrases.
- We will call all names like *Tarzan* and *Rover* Proper nouns (NP). Specific names of persons, places, objects, and institutions, such as Elizabeth, Tennessee, Oldsmobile, Microsoft, and Harvard, are proper nouns. In our example above, the noun phrase does not have an article in front of it. Therefore, we would need an additional noun-phrase rule to describe them:
NP -----> NC
- If *Tarzan* and *Tennessee* are proper nouns, let us call the more generalized nouns, the ones that are used as proper names and are not usually begun with upper-case letters,

COMMON NOUNS (NC). Examples of common nouns are *sophomore, state, car, company, and college*. Therefore, we can revise our rule above accordingly:

NP -----> NP

NP-----> Art NC

Examples:

The engineer startled Sidney

Ali bought a car

Transitive & Intransitive Verbs

- # Earlier we defined verb phrases as:

VP -----> V NP

- **Now consider the following examples:**

The monkey wheezed.

The monkey laughs.

The monkey died.

- Here the verb phrase seems to consist of a single word. Lone words that we saw in the examples will be called **INTRANSITIVE VERBS (VI)**. Wheezed, laughs, and died are all intransitive verbs. Another way of describing them is to say that an intransitive verb is a verb that is not followed by a noun phrase. In contrast, verbs like saw, imitated, and resembles are all **TRANSITIVE VERBS (VT)**, because each is followed by a noun phrase. Some verbs can be used in either category (**The game ended**) (**A riot ended the game**).

Some verbs can be used in either category:

(The game ended)

(A riot ended the game).

- We already noted that the first noun phrase in our examples is often referred to as **SUBJECT** of the sentence. Similarly the noun phrase that follows a verb is often called the **DIRECT OBJECT**. A transitive **verb** is said to take a direct object, while an intransitive verb does not.
- The similarity between transitive and intransitive verbs leads us to classify them in the same general category: **VERBS**. We have considered verbs from a purely structural point of view. In traditional grammar, however, they are defined in terms of meaning: *A verb is a word that expresses action or being.*

We can revise our verb-phrase rule to account for the existence of both intransitive and transitive verbs:

VP -----> VI

VP -----> VT NP

Examples:

The rain continued.
The rain annoyed Paul.

Simplifying the Phrase-Structure Rules

NP -----> Art NC
NP-----> NP

- These rules can generate the following noun phrases in the following

Examples:

Chevrolet hired Ralph
Ramona ordered a pizza

- But sometimes proper nouns are preceded by an article, and sometimes common nouns are not.

Examples:

Ralph own a Chevrolet
Ramona loves pizza

Simplifying the Phrase-Structure Rules

- It would seem, then, that at least four different rules are needed for describing noun phrases:
 - a-** NP -----> NC
 - b-** NP -----> Art NC
 - c-** NP -----> NP
 - d-** NP -----> Art NP

The grammar is now getting unpleasantly complicated. Is there anything we can do about it? Fortunately there is. Because *a and b* are so similar to *c and d*. We can simplify the way we write rules for noun phrases>>>>Let's replace the rules (*a-d*) with two general rules:

**** We will no longer bother about the distinction between PROPER & COMMON nouns.

NP -----> N
NP -----> Art N

Simplifying the Phrase-Structure Rules

Of course not every noun can take an article, therefore we can summarize the two rules earlier in a single statement. A noun phrase contains a noun, which may or may not be preceded by an article. In the writing of phrase-structure rules, PARENTHESES () allow us to express OPTIONAL elements.

NP -----> (Art) N

In the same manner, we will no longer note the distinction between transitive and intransitive verbs. We will write one rule that is equivalent to the two rules presented earlier.

VP -----> V (NP)

Exercises

- 1- Draw tree diagrams for the following sentences:
 - a. A sailor sneezed.
 - b. Lucy threatened the librarian.
 - c. The company fired Mansour.
 - d. Mohammed loves London.

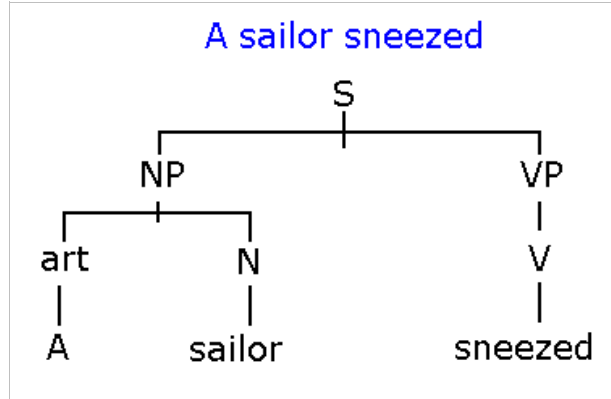

6th lecture

Adjectives & Linking Verbs

Adjectives

- Articles are not the only optional elements that can occur in noun phrases. Consider the noun phrases in these sentences:

noun phrases in these sentences:

- The tiresome monkey saw a leopard.
- Severe storms battered Florida.
- An unscrupulous jeweler sold defective watches.
- The words **tiresome**, **severe**, **unscrupulous**, and **defective**, are all **adjectives (Adj)**.

In traditional grammar this category is defined as follows:

- An adjective is a word that describes or modifies a noun.

- All the following combinations of articles, adjectives, and nouns can occur in English noun phrases:

- NP -----> N
- NP -----> Art N
- NP -----> Adj N
- NP -----> Art Adj N

By using parentheses, we can write a single rule for noun phrases that will account for all structures:

- NP -----> (Art) (Adj) N

This rule allows our grammar to generate sentences such as the following:

An unscrupulous jeweler
sold defective watches

The rule above is still not perfect, because sometimes more than one adjective can occur in a noun phrase:

-the old gray mare expensive new red sneakers
One solution would be to add additional optional adjectives to our NP rule.

The following rule allow one, two, three adjectives in a noun phrase:

NP----> (Art) (Adj) (Adj)
(Adj) N

You can easily think of a noun phrase with more than three adjectives:

the old old old old old philosopher.
Theoretically, there is no limit to the number of adjectives that can modify a single noun.

From now on, let's write such rule as the following:

NP ----> (Art) (Adj)+ N

The above rule can generate sentences such as these:

An officer rewarded the adventurous soldier.
The gaudy purple shirt embarrassed Amanda.

Linking Verbs

- According to the traditional definition of a verb (“ a word that expresses action or being”), not all verbs are action verbs. The others, verbs that “ express being,” are mostly forms of the verb *be*. These forms of *be* (**such as am, is, are, was, and were**), act as the verbal equivalents of an equal sign “=“: They tell us that one thing is equivalent to another.
- Mansour is an honorable man.
- The Cowboys were the winners.
- Tom was persistent.
- Such verbs are distinguished from both transitive and intransitive verbs. They are usually called “ **Linking Verbs**” (VL). They are also known as **copulas**. Like a transitive verb, a linking verb can be followed by a noun phrase. Unlike other verbs, however, a linking verb can also be followed by an adjective.

VP ----> VL NP

VP ----> VL Adj

- Frank was an architect.
- The shoes are uncomfortable.
- Recall that a noun phrase that follows a transitive verb is called the direct object. In traditional grammar, a noun phrase that follows a linking verb, such as an architect, is sometimes called a predicate nominative. An adjective that follows a linking verb,

such as uncomfortable, is sometimes called predicate adjective. Together, predicate nominatives and predicate adjectives are called subjective complements in traditional grammar, because they are said to complete or explain the subject.

- **In addition to forms of the verb *be*, a few other verbs are also linking verbs as the following:**
- An unknown lawyer became the next governor.
- Ferdinand seems intelligent.
- Both *became* and *seems* are linking verbs because they also function much like verbal equal signs. Notice that you can substitute a form of *be* for these verbs and get roughly equivalent sentences.
- An unknown lawyer was the next governor.
- Ferdinand is intelligent.

Several verbs related to the five senses (look, appears, sound, smell, taste, feel) and a handful of other verbs (remain, grow, get, act) sometimes act as linking verbs and sometimes act as transitive verbs, depending on how they are used.

| | |
|---|--|
| - Carolina felt the sandpaper. - Carolina felt angry. | (transitive: felt is an action) (linking: she was angry) |
| - Marcus smelled the flowers. - The flowers smelled sweet. | (transitive: smelled is an action) (linking: they were sweet) |
| - Others left, Sarah remained. - Sarah remained the treasurer. | (intransitive: remained is something she did) (linking: she was the treasurer) |

- Now we can write a single rule for all of the above:
- VP -----> VL { NP or Adj }

Exercises

- 1- Underline the verb in each of the following sentences, and identify it as a transitive verb, an intransitive verb, or a linking verb. For each linking verb, state whether it is followed by a noun phrase or by an adjective.
 - Mom grew impatient.
 - Dad grew a moustache.
 - The baby grew.
 - Abdullah sounded confident.
 - Honesty seemed the best policy.
 - Mar tasted the soup.
 - Khalifah tower looks marvelous.
 - Wayne got a headache.
- 2- Draw a tree diagram for three of the above sentences.

Prepositions

Prepositions

- So far, our grammar-making is moving along nicely, and the model grammar that we have discovered can now generate many different kinds of sentences. Still, it cannot generate all of them, and you have probably spotted some of its inadequacies.

Consider the following sentences:

- John scrambled over the barricade.
- The smugglers sneaked the contraband past the guards.
- The genetic researchers crossed a tiger with a lion.
- Each of these phrases has the intuitive feel of a unit, and each consists of a noun phrase preceded by a word such as **over**, **past**, or **with**. We will call words of this kind **PREPOSITIONS (P)** because they are placed before noun phrases. The word *over* is a preposition, and the entire constituent **over** the barricade can be called a **PREPOSITIONAL PHRASE (PP)**. A prepositional phrase consists of a preposition followed by a noun phrase.
- **PP ----> P NP**

In the examples above, the prepositional phrases occur at the end of sentences. But... Is the prepositional phrase part of the verb phrase, or is it a separate major constituent of the sentence?. These two options for writing phrase-structure rules involving prepositional phrases are shown in the following rules: (John scrambled over the barricade)

| | | |
|------------------------|------------|----------------------|
| - S ----> NP VP | Or: | - S ----> NP VP (PP) |
| - VP ----> V (NP) (PP) | | - VP ----> V (NP) |

Both options work in the sense that both can generate the desired sentence, but Does one tree better reflect our intuitions about the structure of the sentence?

One reason to prefer the first option/rule, which has the prepositional phrase as a constituent of the verb phrase, has to do with meaning: *Over the barricade* should be considered part of the verb phrase, because it **'modifies' or 'completes'** the verb *scrambled*.

That is, it describes where the scrambling took place. Accordingly, we will adopt the first rule and reject the second one and that is:

S ----> NP VP
 VP ----> V (NP) (PP)

Beth jumped from the table.

Larry opened the oyster with a knife.

Prepositional Phrases within Noun Phrases

- Each of the prepositional phrases we have so far considered has occurred within a verb phrase. These prepositional phrases can be said to ‘modify’ the verbs they follow in that they provide information telling when, where, how, or why the action took place.
- **Now consider the following sentences:**
The house *on the hill* overlooked the valley.
The cover *of the book* attracted attention.
The old man *with the harmonica* knew the words to the songs.
None of the italicized prepositional phrases seems to be modifying a verb. Instead, each identifies the noun that it follows and so can be said to modify that noun. For example, *on the hill* tells us which house overlooked the valley.
- **Therefore, we can revise our noun-phrase rule accordingly:**
NP----> (Art) (Adj)+ N (PP)
- The old man with the harmonica knew the words to the song.
- We have now seen prepositional phrases that modify verbs and others that modify nouns. You may wonder if there is a way to determine which is which.
- **The phrase’s position in the sentence is not necessarily an indicatio. Consider the following examples:**
 - Joe hit the ball with the bat.
 - Joe admired the woman with the hat.
 - It is necessary to consider meaning of a prepositional phrase and the purpose it serves in the sentence in order to identify which element it modifies. For example, *with the bat* tells us how Joe did the hitting. Consequently, it modifies the verb *hit* and is a constituent of a verb phrase. In the second example, *with the hat* does not tell us how Joe did the admiring (he didn’t admire her with a hat). Instead it tells us which woman we are talking about. It modifies the noun *woman* and is a constituent of a noun phrase.
 - Joe hit the ball with the bat.
 - Joe admired the woman with the hat.

Exercises

1- Draw tree diagrams for these sentences:

Joe cleaned the grease from the axel.

Saud flew across Tibet.

The contents of the box puzzled Cassandra.

2- Underline the prepositional phrases in the following sentences. For each prepositional phrase, state whether it is a constituent of a verb phrase or a of a noun phrase.

Mahmoud steered the boat through rough seas.

Lulu met a woman from Lithuania.

SYNTAX & MORPHOLOGY

- Of the three persons, FIRST PERSON refers to the speaker; SECOND PERSON refers to the hearer (the person spoken to); and THIRD PERSON refers to the person or thing being spoken about.
- A SINGULAR pronoun refers to, of course, to a single person or thing, while a PLURAL pronoun refers to more than one.
- Notice that for the SECOND PERSON, **you** is used for both SINGULAR and PLURAL.
- The difference between I and me (and between we/us, she/her, and the other pairs) is that the former (I, we, she and so on) are said to be in the NOMINATIVE or SUBJECTIVE CASE, while the latter (me, us, her and so on) are said to be in the OBJECTIVE CASE.
- The nominative form is used for a sentence's SUBJECT (the noun phrase that precedes the verb), while the objective form is used for a DIRECT OBJECT (the noun phrase that follows a transitive verb) or for an OBJECT OF A PREPOSITION (the noun phrase that follows a preposition).

Consider the following example:

-(I, we, she, he, they) introduced (me, us, her, him, them) to (me, us, her, him, them)

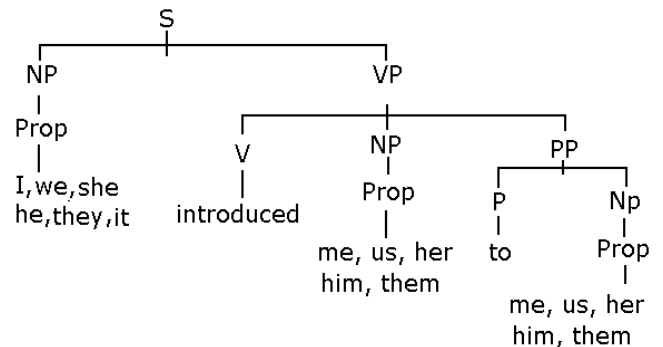

Exercises

1- Draw trees for the following sentences:

- We warned her.

- A present for them arrived in the mail.

- The collision broke it into pieces.

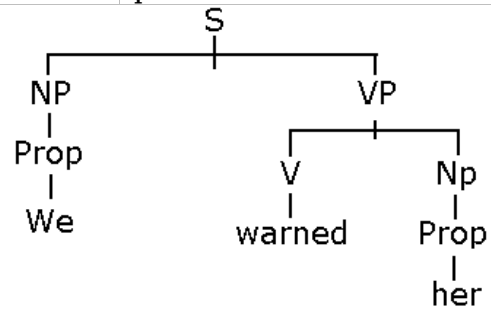
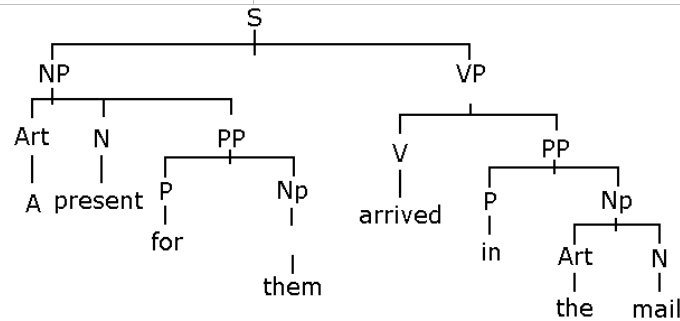

Coordinate Phrases

Coordinate Noun Phrases

- Our rules seem to be getting more and more complex. To the simple noun-phrase rule that we introduced earlier. We have added provisions for optional adjectives, prepositional phrases, and pronouns:

- NP ----> { (Art) (Adj)+ N (PP) }
Prop

And we are not finished yet! At times a noun phrase can have a kind of collective membership:

- The man and the woman greeted Donald.
- The workers demanded higher pay and better benefits.
- They struggled without food or a reliable source of water.
- The first sentence has only one verb phrase (greeted Donald), but two noun phrases seem to constitute its subject (the man and the woman, joined by the word *and*). In the second sentence, two noun phrases joined by *and* constitute the sentence's direct object. In the third sentence, two noun phrases joined by *or* act as the object of the preposition phrase without. The words *and* and *or*, which connect the noun phrases, are called COORDINATING CONJUNCTIONS (Cco).
- To account for the first sentence, we will say that the subject noun phrase (the man and the woman) has as its constituents two different noun phrases joined by a coordinator.
- That is, one overall noun phrase (the man and the woman) consists of two smaller individual phrases (the man, the woman) linked together by a coordinating conjunction. Such a noun phrase is known as a COORDINATE NOUN PHRASE. The rule that would allow

- **noun phrases with this structure is the following:**

NP ----> NP Cco NP

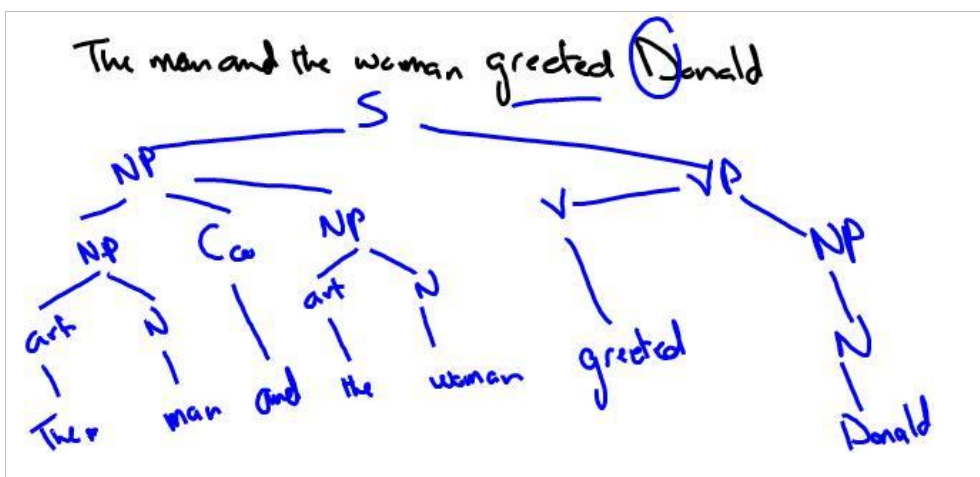

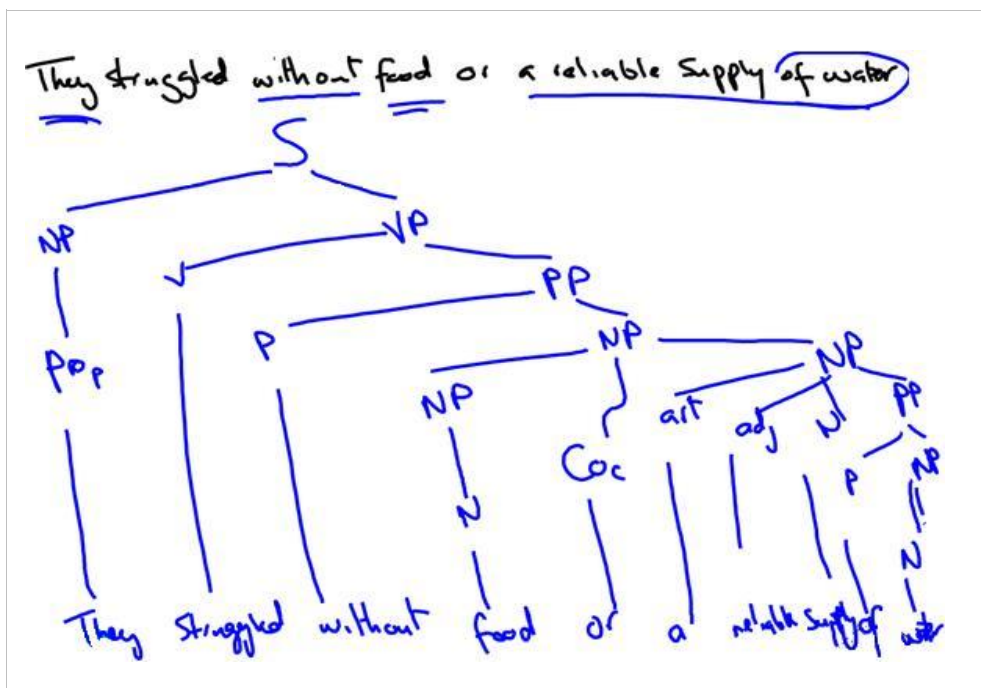
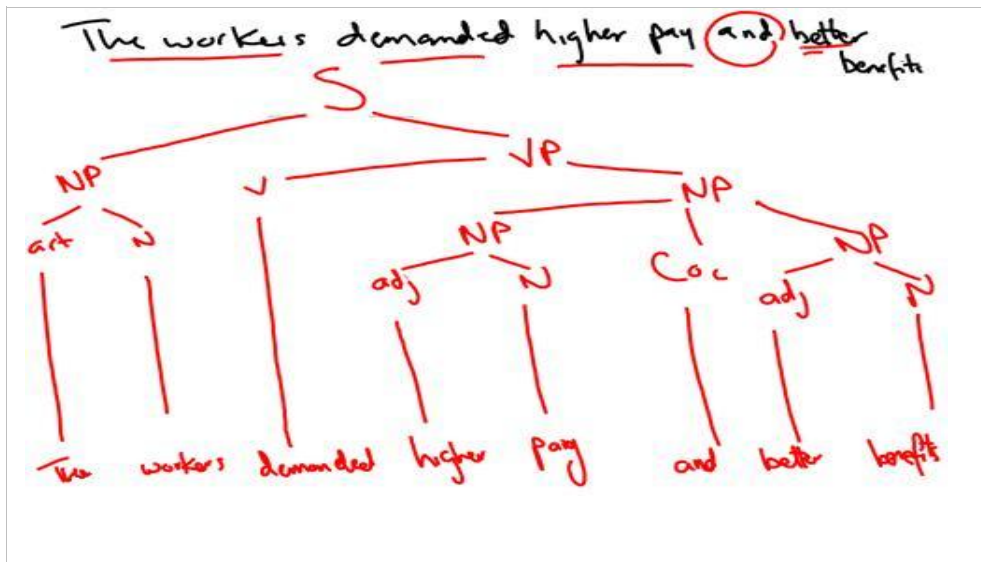

Other Conjoined Phrases

- Noun phrases are not the only phrases that can be joined by conjunctions. In the following sentence, a single person performs two different actions.
- James loved Susan but married Sarah.
- The sentence has one subject noun phrase (James) but two verb phrases (loved Susan and married Sarah) joined by a conjunction (*but*). A rule is needed to account for coordinate verb phrases.
VP ----> VP Cco VP
- We can have coordinate noun phrases and coordinate verb phrases.

Can any other phrases be linked by conjunctions? Consider the following sentence:

- Stephanie stepped off the pier and into the lake.

- Here the coordinating conjunction and connects two prepositional phrases (off the pier and into the lake).
- **Let us add the following rule to our grammar:**
PP -----> PP Cco PP

Notice that we now have three quite similar rules for coordinate phrases:

NP -----> NP Cco NP
VP -----> VP Cco VP
PP -----> PP Cco PP

Let us simplify it to the following:

- XP -----> XP Cco XP

Exercises

- 1- Draw trees for the following sentences.
The rain and the insects spoiled the party.
Tom did the work but failed the oral exam.
People from Austria and from Germany speak the same language.

10th lecture

Complement Clauses

Sentential- Complement Clauses

We observed that noun phrases can take various forms. For example, the direct-object slot in the following sentences can be filled by many different kinds of constituents, including one that we have not previously seen:

- Darlene believed me [NP = Prop]
- Darlene believed the story [NP = Art + N]
- Darlene believed Mark and Betsy [NP + Cco + NP]
- Darlene believed that Max broke the type writer [NP = that + S]

In the last sentence, the object noun phrase, the thing that Darlene believed , is a entire clause. Such clauses are called COMPLEMENT CLAUSES or SENTENTIAL COMPLEMENT CLAUSES, because they are clauses that complement (or complete) the main clause. They are also called NOMINAL CLAUSES because they function as noun phrases.

- **Sentential-complement clauses can occur either as subjects or as objects of sentences:**
- **That** Tom remembered the appointment amazed the doctor.

- The doctor warned *that* nicotine causes cancer.

The word *that*, which introduces the complement clauses in the two sentences, is called COMPLEMENTIZER or COMPLEMENTIZING CONJUNCTION (CCI). Notice that the word *that* in these sentences has no meaning by itself, but rather it acts as a kind of verbal signpost, alerting the listener or reader that a complement clause is about to follow.

- We will represent complement clauses by the abbreviation (CompP). The **P** in the abbreviation stands for PHRASE. **The following additional NP rule expresses our discovery that a noun phrase can be an entire complement clause:**

NP -----> CompP

- That Tom remembered the appointment amazed the doctor.
- The doctor warned that nicotine causes cancer.

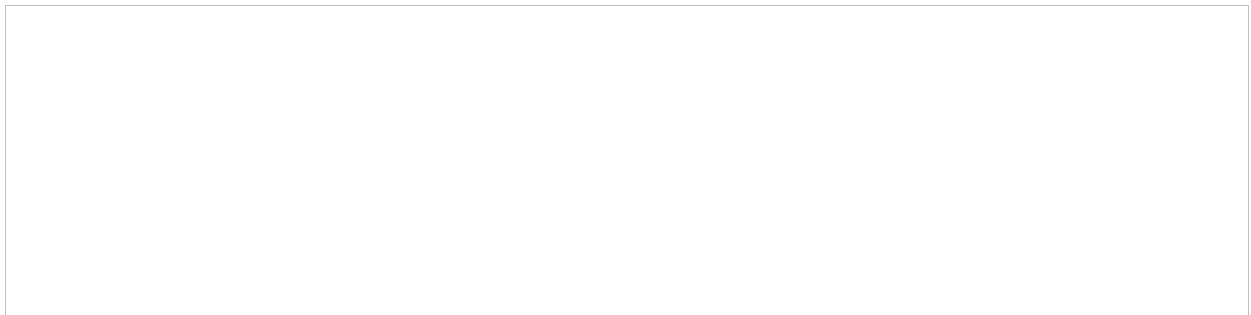

- Notice that in the first sentence, something amazed the doctor. The something could have been a simple noun phrase (such as the trick), but instead what amazed the doctor is expressed in a complete sentence, namely, that Tom remembered the appointment. We can observe then, that each of the two complement clauses consists of the COMPLEMENTIZER (*that*) and an S-Clause.

We can state this observation in the following rule:

CompP -----> CCI S

With the above rules, we can draw the complete trees for the previous sentences:

- That Tom remembered the appointment amazed the doctor.
- The doctor warned that nicotine causes cancer.

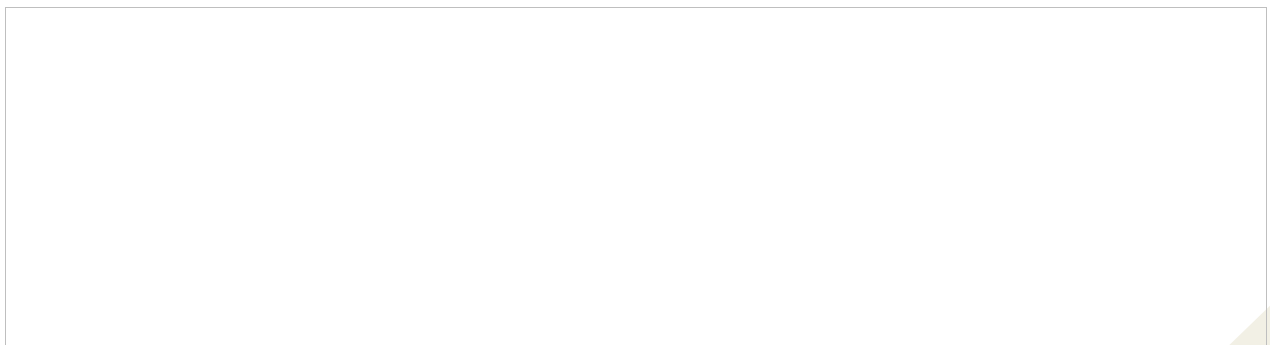

In a sentence with a sentential-complement clause, the complement clause acts as a noun phrase:

- That the neighbors threw a wild party angered Mark.
In the following sentences, however, complement clauses follow (and complement) noun:
- The fact that the neighbors threw a wild party angered Mark.

Adjectival-Complement Clauses

In the previous example, the nominal-complement clause follows a noun and completes the noun's meaning. Now consider the following examples:

- Mark was angry that the neighbors threw a wild party.
- Linda is confident that she knows the correct answer.

In these examples, the italicized clause complements (explains) the adjective angry and the adjective confident. As you have probably guessed, clauses that complement adjectives are called ADJECTIVAL-COMPLEMENT CLAUSES. Together, the adjective and the complement clause constitute a phrase, which we will call an ADJECTIVAL PHRASE (AdjP).

Therefore, we should consider the following rule:

AdjP -----> Adj (CompP)

| |
|---|
| Mark was angry that the neighbors threw a wild party. |
| |

| |
|---|
| Linda is confident that she knows the correct answer. |
| |

- * *This each* large box of the groceries
- * *John's this* large box of groceries
- * *Each my* large box of groceries
- Finally, like the article, each of the four substitutes must precede the adjectives; none can follow it:
 - * Large *this* box of groceries
 - * Large *each* box groceries
 - * Large *John's* box of groceries
 - * Large *my* box of groceries
- The apparent exception, Large *John's*, has a different meaning. It is ungrammatical if it is to retain the meaning that the box is large.
- From these tests, we conclude that the four words *this, each, John's, and my* do fill the same slot as the article in the noun phrase. A larger category is needed, one that will include articles as well as these four as-yet-unlabeled words. We will call all such words **DETERMINERS** (Det). If we substitute "*Det*" for "*Art*", the rule now becomes:
NP -----> (Det) (Adj)+ N (PP) (CompP)
- Determiners can be a variety of things, including articles as well as the four substitute words. Once we find categories for them, we can insert their names in place of the dotted lines in this rule:

Art
Det -----> { }
.....

Demonstratives and Quantifiers

The words *this, that, these and those* are called **DEMONSTRATIVE MODIFIERS (DEM)** because they demonstrate (point out definitely) which particular box of groceries is being discussed. The word *each* is called a **QUANTIFIER** or **QUANT (also called an INDEFINITE MODIFIERS)**. Other **quantifiers include *all, any, enough, every, few, many more, most, much, no, several, and some***. They are called quantifiers because they quantify (provide quantity information about) the nouns that follow them.

So far we have named three options to fill the missing categories in the previous rule:

Art
Det -----> { Dem }
Quant

Those greedy quests ate several large helpings of the lasagna

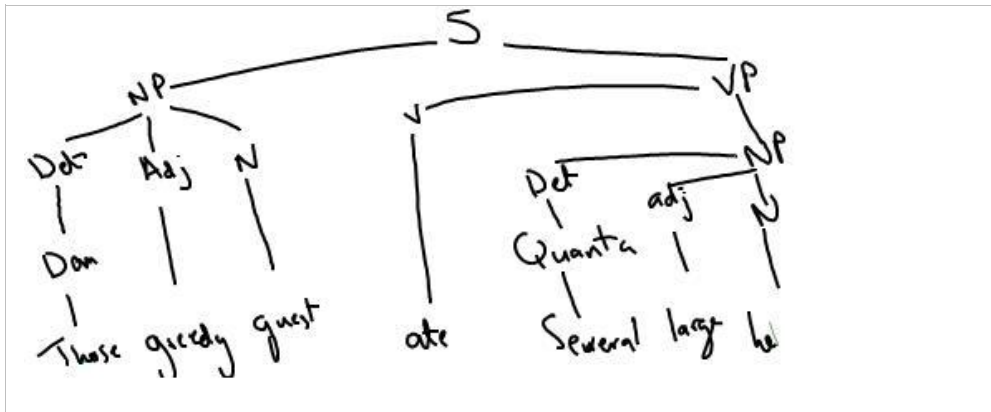

Possessive Pronouns

The third new determiner that we saw in our first example:

My large box of groceries

my, is a POSSESSIVE PRONOUN (more accurately, A POSSESSIVE PERSONAL PRONOUN), which we will abbreviate as (**Prop-s**), with the subscript **P** standing for 'personal' and **S** for 'possessive'.

Whereas personal pronouns act as noun phrases, possessive pronouns act as determiners. With possessive pronouns, we now have four options for determiners:

- Art
- Det -----> { Dem }
- Quant
- Prop-s

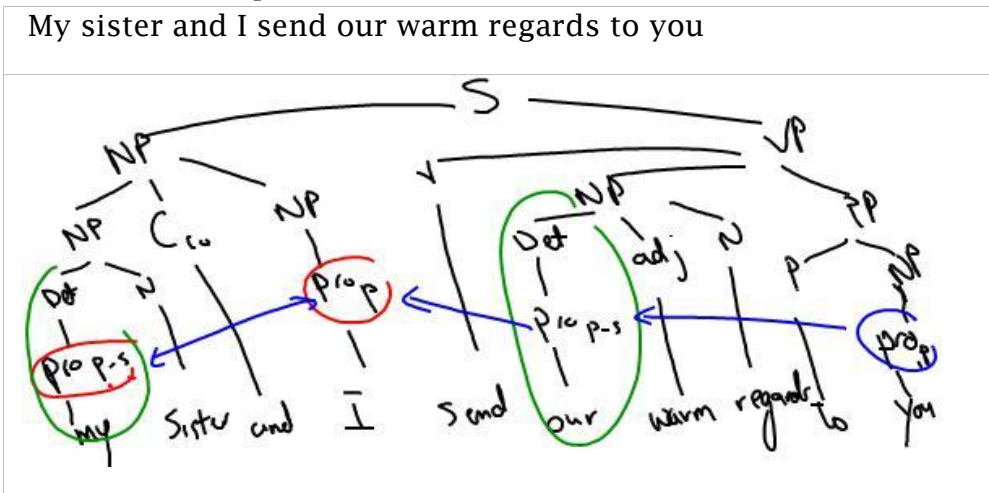

Possessive Noun Phrase

The final example of determiners, *John's*, is a POSSESSIVE NOUN PHRASE ('s and ') possessive markers as Poss....

- *John's* large box of groceries

Like a possessive pronoun, its purpose is to indicate ownership. Although John's is the possessive form of a single noun (John), multiword noun phrases can also have possessive forms, **as the following indicates:**

- John's* large box of groceries
- The boy's* large box of groceries
- A small family's* large box of groceries
- My boss's* large box of groceries

Now consider this final option for determiners:

Art
 Det -----> { Dem }
 Quant
 Prop-s
 NP Poss

12th lecture

Adverbials

Adverbs

One major part of speech that we have not yet explored is the ADVERB (Adv). Adverbs can modify verbs, because they tell how, when, where, or why the action occurred.

Consider the italicized adverb in the sentence:

Frank gazed at the sky intently

Intently tells how Frank did the gazing, and so it modifies the verb gazed. We can add an adverb option to our VP rule:

$$VP \text{ -----} \rightarrow \left\{ \begin{array}{l} V \quad (NP) \\ VL \quad \{ NP \} \\ \quad \quad AdjP \end{array} \right\} (PP) (Adv)$$

| |
|---------------------------------|
| Frank gazed at the sky intently |
| |

- **Most adverbs are easy to spot because they are formed by adding the suffix -- ly to an adjective:**
 rapidly, angrily, happily. Adverbs that do not end in -ly include *well, much, little, once, once, twice*, as well as many adverbs of time such as *often, soon, yesterday, now, and then* and many adverbs of place such as *here, there, eastward, and skyward*.
- While it can generate sentence like the one above, the above rule is still not satisfactory. It can generate an adverb following a prepositional phrase, **but some grammatical sentences have the reverse order:**
 Frank gazed intently at the sky
- Perhaps, we also need a second verb-phrase rule to allow for adverbs that precede prepositional phrases.

Adverbials That follow Linking Verbs

- Earlier, we saw that a linking verb can be followed by a noun phrase (for example ...**The plane is a jet**) or an adjective (for example... **The plane is new**). **An adverbial phrase can also follow a linking verb:**
The plane is here
The plane is on the runway
The departure is tomorrow
The departure is after the rainstorm
- **We can state this option as a phrase-structure rule:**
VP -----> VL AdvP
- Unfortunately, however, the previous rule is too powerful, meaning that it can generate some unwanted phrases. Only some --- not all --- adverbials can follow a linking verb. That is, a linking verb can be followed by **a place adverbial such as here and on the runway** or **by a time adverbial such as tomorrow and after the rainstorm**. But a linking verb cannot usually be followed by a manner adverbial such as beautifully or with enthusiasm. That is, we do not want the above rule to generate sentences such as (* **The plane is beautifully**).
- Fortunately, we can solve our problem if we differentiate between the standard unrestricted adverbials that modify a verb (which we can continue to call AdvP) and the time/place adverbials that follow a linking verb, which we might label AdvPL.

Rules for these two forms of adverbials are:

AdvP -----> { Adv }
 PP
AdvPL -----> { Adv (Time/Place) }
 PP (Time/Place)

With this distinction, we can update our rule for linking verbs as follows:

VP -----> VL { NP
 AdjP }
 AdvPL

Morphology

Morphology

- In many languages, what appear to be single forms actually turn out to contain a large number of “word-like” elements. For example, in Swahili (spoken throughout East Africa), the form **nitakupenda** conveys what, in English, would have to be represented as something like **I will love you**. Now, is the Swahili form a single word? If it is a “word” then it seems to consist of a number of elements which, in English, turn up as separate “words”.

A rough correspondence can be presented in the following way:

ni-- ta-- ku-- penda
“ I will love you “

- It would seem that this Swahili “word” is rather different from what we think of as an English “word”. Yet, there clearly is some similarity between the languages, in that similar elements of the whole message can be found in both. Perhaps a better way of looking at linguistic forms in different languages would be to use this notion of ‘element’ in the message, rather than depend on identifying only ‘words’.
- The type of exercise we have just performed is an example of investigating basic forms in language, generally known as **MORPHOLOGY**. This term, which literally means “ the study of forms,” was originally used in biology, but, since the middle of the 19th century, has also been used to describe the type of investigation that analyzes all those basic “elements” used in a language. What we have been describing as ‘ elements’ in the form of a linguistic message are technically known as **MORPHEMES**.
- We can recognize that English word forms such as **talks, talker, talked and talking** must consist of one element talk, and a number of other elements such as **-s, -er, -ed and -ing**. All these elements are described as MORPHEMES. The definition of a morpheme is “ a minimal unit of meaning or grammatical function”. Units of grammatical function include forms used to indicate past tense or plural, for example.
- In the sentence, ...The police reopened the investigation..., the word **reopened** consists of three morphemes. One minimal unit of meaning is **open**, another minimal unit of meaning is **re-** (meaning again) and a minimal unit of grammatical function is **-ed** (indicated past tense).
- The word **tourists** also contains three morphemes. There is one minimal unit of meaning **tour**, another minimal unit of meaning **-ist** (marking “person who does something”), and a minimal unit of grammatical function **-s** (indicating plural).

Free and Bound Morphemes

- From these examples, we can make a broad distinction between two types of morphemes. There are **FREE MORPHEMES**, that is, morphemes that can stand by themselves as single words, for example *open and tour*.
- There are also **BOUND MORPHEMES**, which are those forms that cannot normally stand alone and are typically attached to another form, exemplified as *re--*, *--ist*, *--ed*, *--s*.
-
- These forms are called **AFFIXES**. So, we can say that all affixes (PREFIXES and SUFFIXES) in English are bound morphemes. The free morphemes can generally be identified as the set of separate English word forms such as basic nouns, adjectives, verbs, etc.

- When they are used with bound morphemes attached, **the basic word forms are technically known as STEMS. For example:**

| | | | | | |
|---------------|--------------|---------------|-------------|---------------|---------------|
| un-- | dress | ed | care | --less | --ness |
| prefix | stem | suffix | stem | suffix | suffix |
| bound | free | bound | free | bound | bound |

Lexical and Functional Morphemes

- What we have described as free morphemes fall into two categories. The first category is that set of ordinary nouns, adjectives, and verbs that we think of as the words that carry the content of the messages we convey.

These free morphemes are called LEXICAL MORPHEMES and some examples are : girl, man, house, tiger, sad, long, yellow, sincere, open, look, follow, break. We can add new lexical morphemes to the language rather easily, so they are treated as an “**OPEN**” class of words.

- **Other types of free morphemes are called FUNCTIONAL MORPHEMES.** Examples are and, but, when, because, on, near, above, in, the, that, it, them. This set consists largely of the functional words in the language such as conjunctions, prepositions, articles and pronouns. Because we almost never add new functional morphemes to the language, they are described as a “**CLOSED**” class of words.

Derivational and Inflectional Morphemes

- The set of affixes that make up the category of bound morphemes can also be divided into two types. One type is described in terms of the derivation of words. These are the **DERIVATIONAL MORPHEMES**. We use these bound morphemes to make new words or to make words of a different grammatical category from the stem. For example, the addition of the derivational morpheme *-ness* changes the adjective *good* to the noun *goodness*.

SYNTAX & MORPHOLOGY

- The noun *care* can become the adjective *careful* or *careless* by the addition of the derivational morphemes *-ful* or *-less*. A list of derivational morphemes will include suffixes such as *-ish in foolish*, *-ly in quickly*, and the *-ment in payment*. The list will also include prefixes such as *re-*, *ex-*, *mis-*, *co-*, *un-* and many more.
- The second set of bound morphemes contains what are called INFLECTIONAL MORPHEMES. These are not used to produce new words in the language, but rather to indicate aspect of the grammatical function of a word. Inflectional morphemes are used to show if a word is plural or singular, if it is a comparative or possessive form. English has only 8 inflectional morphemes (or 'inflections'), illustrated in the following sentences.
- Jim's two sisters are really different.
- One likes to have fun and is always laughing.
- The other liked to read as a child and has always taken things seriously.
- One is the loudest person in the house and the other is quieter than a mouse.
- In the first sentence, both inflections (*'s*, *-s*) are attached to nouns, one marking **possessive** and the other marking **plural**. Note that *-s* here is a possessive inflection and different from *-s* used as an abbreviation for is or has (e.g. *she's singing*, *it's happened again*).

There are four inflections attached to verbs:

--s (3rd person singular), *--ing* (present participle), *--ed* (past tense), and *--en* (past participle).

There are two inflections attached to adjectives:

--er (comparative) and *--est* (superlative). In English, all the inflectional morphemes are suffixes.

Morphology

Morphological Description

- The difference between derivational and inflectional morphemes is worth emphasizing. An inflectional morpheme never changes the grammatical category of a word. For example, both *old* and *older* are adjectives. The *-er* inflection here simply creates a different version of the adjective. However, a derivational morpheme can change the grammatical category of a word. The verb *teach* becomes the noun *teacher* if we add the derivational morpheme *-er*. So, the suffix *-er* in English can be inflectional morpheme as part of an adjective and also a distinct derivational morpheme as part of a noun. Just because they look the same (*--er*) doesn't mean they do the same kind of work.
- Whenever there is a derivational suffix and inflectional suffix attached to the same word, they always appear in that order. First the derivational (*--er*) is attached to *teach*, then the inflectional (*--s*) is added to produce *teachers*.
- Armed with all these terms for different types of morphemes, we can now take more sentences of English apart and list all the "elements". For example. In the sentence: The child's wildness shocked the teachers, we can identify eleven morphemes.
- The (functional) child (lexical) --'s (inflectional) wild (lexical) --ness (derivational) shock (lexical) --ed (inflectional) the (functional) teach (lexical) --er (derivational) --s (inflectional)
- **A useful way to remember all these different types of morphemes is in the following:**
Morphemes: free (either lexical ' child & teach) or functional ' the')
Morphemes: bound (either derivational ' -ness' or inflectional ' -'s, --ed)

Problems in Morphological Description

- The description before conceals a number of outstanding problems in the analysis of English morphology. So far, we have only considered examples of English words in which different morphemes are easily identifiable as separate elements. The inflectional morpheme *-s* is added to *cat* and we get the plural *cats*. What is the inflectional morpheme that makes *sheep* the plural of *sheep*, or *men* the plural of *man*? And if *-al* is the derivational suffix added to the stem *institution* to give us *institutional*, then we can take *-al* off the word *legal* to get the stem *leg*? Unfortunately, the answer is "No".

Morphs and Allomorphs

- One way to treat differences in inflectional morphemes is by proposing variation in morphological realization rules. In order to this, we draw an analogy with some processes already noted in phonology. Just as we treated phones as the actual phonetic realization of phonemes, so we can propose MORPHS as the actual forms used to realize morphemes. For example, the form cats consists of two morphs, **cat + -s**, realizing a lexical morpheme and an inflectional morpheme (plural). The form buses consists of two morphs (**bus + -es**), realizing a lexical morpheme and an inflectional morpheme (plural). So, there are at least two different morphs (**--s and -es**, actually /s/ and /ez/) used to realize the inflectional morpheme “plural”. Just as we noted that there were “allophones” of a particular phonemes, so we can recognize the existence of **ALLOMORPHS** of a particular morpheme. That is, when we find a group of different morphs, all versions of one morpheme, we can use the prefix allo- (one of a closely related set) and describe them as allomorphs of the morpheme.
- Take the morpheme “plural”. Note that it can be attached to a number of lexical morphemes to produce structures like “**cat + plural**”, “**bus + plural**”, “**sheep + plural**” and “**man + plural**”. In each of these examples, the actual forms of the morphs that result from the morpheme “plural” are different. Yet they are all allomorphs of the one morpheme. So, in addition to /s/ and /ez/, another allomorph of “plural” in English seems to be a **zero-morph** because the plural form of sheep is actually “**sheep + zero**”. When we look at “**man + plural**”, we have a vowel change in the word as the morph that produces the irregular plural form of **men**.
- There are a number of other morphological processes at work in a language like English, such as those involved in the range of allomorphs for the morpheme “**past tense**”. These include the common pattern in “**walk + past tense**” that produces **walked** and also special pattern that takes “**go + past tense**” and produces “**irregular**” past from **went**.

Internal Change

Internal change is a process that substitutes one non-morphemic segment for another.

| | |
|------------------|----------------|
| Sing (present) | sang (past) |
| Sink (present) | sank (past) |
| Drive (present) | drove (past) |
| Foot (singular) | feet (plural) |
| Goose (singular) | geese (plural) |

Verbs such as **sing, sink, and drive** form their past tense by changing the vowel (e.g., from *i* to *a* in the first two examples). The term **ABLAUT** is often used for vowel alternation that mark grammatical contrast in this way. Ablaut can be distinguished from **UMLAUT**, which involves the fronting of a vowel under the influence of a front

vowel in the following syllable. Historically, this is what is responsible for the use of *feet* and *geese* as plural forms of *foot* and *goose*.

Stress and Tone Placement

Sometimes, a base can undergo a change in the placement of stress or tone to reflect a change in its category. In English, for example, there are pairs of words such as the following in which the verb has stress on the final syllable while the corresponding noun is stressed on the first syllable.

| | |
|-----------------|-----------------|
| Impl`ant (verb) | `implant (noun) |
| imp`ort (verb) | `import (noun) |
| pres`ent (verb) | pr`esent (noun) |
| subj`ect (verb) | s`ubject (noun) |
| Cont`est (verb) | c`ontest (noun) |

Compounding

Still another common morphological process in human language involves **COMPOUNDING**, the combination of lexical categories (nouns, adjective, verbs, or prepositions) to create a larger word.

There are countless compounds in English, some of which are the following:

- Street+light (noun+noun)
- Book+case (noun+noun)
- Blue+bird (adjective+noun)
- Happy+hour (adjective+noun)
- High+chair (adjective+noun)
- Swear+word (verb+ noun)
- Scrub+lady (verb+noun)
- Over+load (preposition+noun)
- Out+house (prepostion+noun)
- In+group (preposition+noun)