

13 Management and Support Issues in Wireless

13.1	INTRODUCTION	13-4
13.2	STRATEGIC PLANNING.....	13-6
13.2.1	<i>Business Strategy Analysis</i>	13-6
13.2.2	<i>Analyzing Business Processes and Business Workflows</i>	13-11
13.2.3	<i>Mobile Application Identification and Selection</i>	13-14
13.3	CAPABILITY EVALUATION AND ARCHITECTURAL VISION	13-16
13.3.1	<i>Architecture Analysis to Support Mobility</i>	13-16
13.3.2	<i>Wireless Infrastructure Planning – Identifying Technical Capabilities</i>	13-17
13.3.3	<i>Capacity Planning and Traffic Engineering</i>	13-19
13.3.4	<i>Resource and Cost Estimation/Evaluation</i>	13-24
13.4	DEVELOPMENT AND DEPLOYMENT CONSIDERATIONS	13-24
13.4.1	<i>Analysis of Mobile Application Development Choices</i>	13-26
13.4.2	<i>In-House Development and Deployment of Mobile Applications</i>	13-27
13.4.3	<i>Acquisition and Installation of Wireless Infrastructure</i>	13-29
13.4.4	<i>Renting and Outsourcing Through Service Providers</i>	13-29
13.4.5	<i>Application Renting and Outsourcing Through Wireless ASPs</i>	13-31
13.5	MONITORING AND CONTROL – WIRELESS NETWORK MANAGEMENT.....	13-33
13.5.1	<i>Overview</i>	13-33
13.5.2	<i>Management Platforms – The General Principles</i>	13-34
13.5.3	<i>Principles of Wireless Network Management</i>	13-40
13.5.4	<i>Wireless Network Management Special Cases</i>	13-43
13.5.5	<i>Brief Examples of Wireless Network Management Systems</i>	13-47
13.6	ADMINISTRATIVE AND ORGANIZATIONAL ISSUES	13-48
13.6.1	<i>Organizational Design in M-Business</i>	13-48
13.6.2	<i>Location-Independent Mobile “Virtual” Teams – IT For Organization Design</i>	13-49
13.6.3	<i>Organizational Design in Real-Time Enterprises</i>	13-50
13.7	CHAPTER SUMMARY	13-51
13.8	REVIEW QUESTIONS AND EXERCISES	13-51
13.9	REFERENCES	13-52

Case Study: What Happened to Motorola’s Iridium?

In the mid 1980s, a Motorola-led consortium developed the idea of a platform for mobile telephony that would be far superior than any other available at that time and would dominate the wireless network services. This vision led to the formation of Iridium LLC by Motorola.

Technically, as stated in a previous chapter, Iridium spearheaded LEO (Low Earth Object) technologies for satellites at a massive commercial scale. In 1998, Iridium developed and

launched 66 satellites to support mobile communications for every point on earth and within 50 miles above it. The technical idea of LEOs, as explained in Chapter 9, is to provide large number of extremely high-speed satellites at low orbits so that a satellite is always available to handle user request – if one is moving out of the service zone, another just arrives to take over. Designed to handle universal mobile customer needs, Iridium linked computers, faxes, and telephones around the globe.

Technically, Iridium was a major success because it demonstrated how LEO satellites could be used to cover remote and hard-to-reach areas through landline networks. But it was a business disaster due to business and management issues. When the services were offered to the public in 1999, the reception was lukewarm due to complaints about high cost and technical problems. For example, a customer was expected to pay around \$3000 for an Iridium phone while other cellular phones with similar and better services were available for \$200 at that time. The cost was expected to go down as more users signed up, but users did not sign up because of high cost. In addition, the Iridium telephones were too big, needed a host of attachments to be operational, and did not work in cars or buildings – exactly the places where it was needed.

Due to lack of revenues, Iridium filed for bankruptcy. The company had invested \$5 billion and was bought at \$25 million. New deals and news about the project appear in the press on a regular basis (see www.iridium.com for details).

What went wrong and what are the lesson from this? First, it is not enough to develop technically sound and highly innovative solutions – the customers have to see some benefits before they spend their money. Second, sound business and marketing approaches are needed for a successful product – the pricing and competitive analysis from a customer’s point of view are important. Third, it is not a good idea to rely on market forecasts only. This lesson is also being learned by the companies that invested in 3G technologies.

Sources:

- www.iridium.com
- R. Kalakota, and M. Robinson, *M-Business: The Race to Mobility*, McGraw Hill, 2002

Case Study: Boo.com Gets Booted Out

Boo.com promised its investors and online shoppers a website for online purchasing of high-quality, stylish, designer sportswear. Despite the widespread publicity, Boo.com declared bankruptcy only six months after its website had been launched, causing investors to lose an estimated \$185 million. What went wrong? Here is the story in brief.

The idea for Boo.com came from two 28-year-old Swedish friends who had already established and later sold Bokus.com, which is the world’s third-largest online bookstore after Amazon.com and Barnes&Noble.com. The idea was to sell trendy fashion products over the Web at full retail price rather than at a discount. The website enabled shoppers to view every product in full-color, three-dimensional images, with zooming and rotation capabilities to view them from any angle. The site’s search engine allowed customers to search for items by color, brand, price, style, and even type of sport. In addition, the visitors could get fashion advice from “Miss Boo,” an animated figure, and customer service advice from telephone operators. To further entice buyers, the Boo.com customers earned “loyalty points,” which they could use to obtain discounts on future purchases. The Boo.com website was fluent in seven languages, accepted local currencies from 18 countries, and also offered free delivery

within one week and free returns for dissatisfied customers. In essence, this was to be the dream website for “time poor, cash rich” people.

Boo.com was financially backed by J. P. Morgan & Co. With start-up funds in hand, the company started an advertising campaign and set a target date of May 1999 for launching the website. The management committed \$25 million to an advertising budget and chose to advertise in expensive but trendy fashion magazines, cable television and the Internet. Boo decided to develop both its Internet platform and customer-fulfillment systems from scratch. The overall plan was to launch the websites in 18 countries and handle 100 million Web visitors at once. The management also decided to open satellite offices in Munich, Paris, New York, and Amsterdam and hired several hundred people to take orders from these offices once the site went live. However, the launch date had to be postponed a few times because of incomplete website development, and so many of the staff sat idle for months. By September the company had spent \$70 million, and Boo undertook more fund-raising.

The website was finally launched in early November, 1999. The promised mass marketing blitz never happened. Basically, raising people’s interest through pre-launch advertising while delaying the opening resulted in many disappointed and alienated potential customers. In addition, the site reviews were not good. Many (40 percent) of the site’s visitors could not even gain access. The site was full of errors, and even caused visitors’ computers to freeze. The site was slow and very difficult to use, far from revolutionary. Only 25% of the customers were able to purchase anything and users of Macintosh computers could not even log on because Boo.com was incompatible with them. The flashy graphics and interactive features took too long for users with slow Internet access. Angry customers jammed Boo.com’s customer support lines and sales fell short of expenses. Things started going downhill quickly. Boo lost support from J.P. Morgan and started selling its clothing at a 40 percent discount and laying off staff. Finally, in May 2000, the firm was liquidated with many outstanding bills it could not pay.

So what went wrong? Naturally, one problem was lack of planning and control. No matter what, all businesses need the fundamental activities of budgeting, planning, execution, and control. The company promised too much (e.g., 18 countries simultaneously), spent too much money on advertising and marketing hype (e.g., advertising in expensive magazines and renting offices in high-priced areas in London, Paris, and New York), and just wasted money without return on investment (employees reportedly flew first-class and stayed in five-star hotels). Another problem was the lack of oversight by the board. The board seats were mostly controlled by the Boo management, with only four being allocated to investors. However, those four investor representatives rarely attended board meetings. The board members had no significant retail or Internet experience and were not able to offer the supervision it needed.

In addition, there were serious technical problems. Developing everything from scratch proved slow and expensive. The developers had to develop a complex virtual inventory system, because Boo maintained very little inventory of its own. Boo’s multimedia presentation was complex and even the shopping cart was intricate because one customer might have a shopping cart with items from four or five different sources. The support for seven languages and 18 different currencies with calculations for taxes from 18 different countries is also an extremely complex task. Finally, many homes in the US and Europe lack the high-capacity Internet connections required to easily access the graphics and animation on the Boo.com site. To make matters worse, some supposedly attractive features became flaws. For example, the constant presence of Miss Boo was annoying because she was injected regardless of whether the visitor desired her. In summary, a multitude of management and technical problems killed Boo.com.

Sources:

- K. Laudon and J. Laudon, *Management Information Systems*, 7th ed., Prentice Hall, 2002.
- Michelle Slatalla, "Boo.com Tries Again, Humbled and Retooled," *New York Times*, January 11, 2001.
- Andrew Ross Sorkin, "Boo.com, Online Fashion Retailer, Goes Out of Business," *New York Times*, May 19, 2000.
- Stephanie Gruner, "Trendy Online Retailer Is Reduced to a Cautionary Tale for Investors," *Wall Street Journal*, May 19, 2000.

13.1 Introduction¹

The case studies of Iridium and Boo.com make an important point: business success requires good technology plus a solid business strategy. The Iridium case study shows what happens when you have a marvelous technical vision without a good business model. The reverse is true with Boo.com – there was a great deal of attention paid to business and marketing but the enabling technology was not well thought out. This chapter attempts to tie the business and technical decisions into an overall approach, shown in Figure 13-1. The approach starts with a strategic plan and then goes through capability evaluation, development/deployment, monitoring/control, and organizing/staffing decisions. This discussion suggests a set of iterative activities that can bring to the surface different business as well as technical views in wireless projects in order to avoid disasters like Iridium, Boo.com, and many others. From a management point of view, the wireless projects of any significance should iterate through the following activities:

- **Strategic planning** (Section 13.2) takes a strategic look at business and identifies the role of mobile applications and wireless communications in satisfying the business goals. The focus is on m-business (recall that m-business = Internet + wireless + e-business).
- **Capability evaluation and architecture analysis** (Section 13.3) evaluates the wireless infrastructure (wireless networks, mobile computing platforms) needed to support the mobile applications and m-business initiatives identified in strategic planning. Capacity planning, traffic engineering, and cost estimation are also part of this evaluation.
- **Development and deployment** (Section 13.4) reviews how the capabilities identified will be developed and delivered. The main issues are how to decide between purchasing, developing in-house, renting, and outsourcing options, and then how to deploy the diverse array of wireless hardware/software systems needed.
- **Monitoring and control** (Section 13.5) is concerned with the day-to-day monitoring and control of the deployed systems. The purpose is to assure smooth customer services, because the loss of wireless networks is a disaster at present due to the increased use of wireless LANs and cellular networks in various industries. Of particular importance are the wireless management platforms that are becoming available to monitor the network failures, performance bottlenecks, security breaches, and other problems in wireless systems.
- **Organizing and staffing** (Section 13.6) concentrates on the important issues of organizing and staffing the wireless projects. The objective is to produce an organizational structure that will adequately support the wireless projects. The specific

¹ Throughout this chapter, the term wireless system indicates a complete system that includes the entire stack from mobile computing applications to wireless networks.

issues are mobile virtual teams and the role of mobility to support the next generation of real-time enterprises.

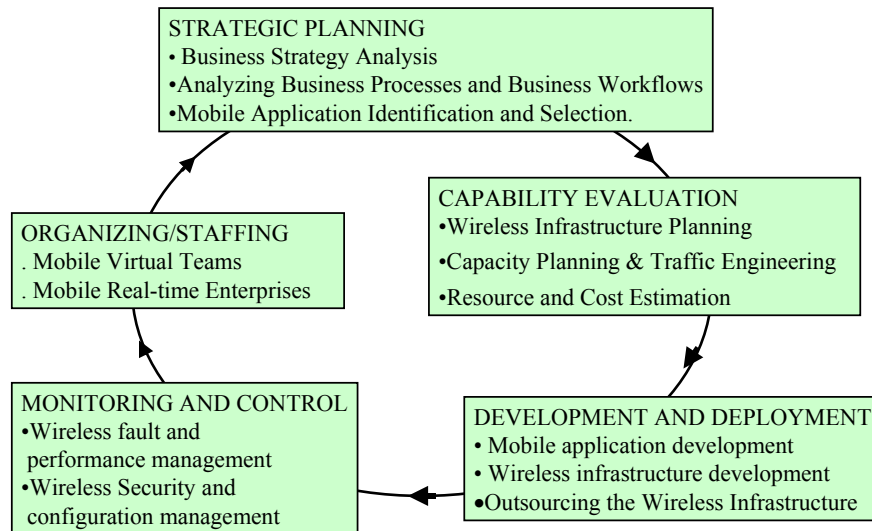

Figure 13-1: Management Activities

Chapter Highlights

- The traditional cycle of planning, organizing, staffing, development, monitoring and control is a good framework for managing wireless projects.
- Strategic planning takes a strategic look at business and identifies the role of m-business in satisfying the business goals. This includes asking questions such as the following:
 - How will the customer benefit from m-business?
 - How will the firms benefit from m-business?
 - Is there a market for what we are building?
 - What unique value do we provide?
 - How will we make money from m-business?
- Capability evaluation and architecture analysis evaluates the wireless infrastructure needed to support the m-business initiatives identified in strategic planning. This includes asking questions such as the following:
 - What new capabilities are needed?
 - Which ones do we already have?
 - What are the basic building blocks of the solution?
 - How will they fit with each other and with the existing systems?
 - Will the new systems be able to handle the traffic expected?
- Development and deployment reviews how the capabilities identified will be developed and delivered. The specific questions that drive this process are:
 - Do we need to purchase, develop in-house, rent, or outsource what we need?
 - What are the best mechanisms for deploying the wireless hardware/software needed?
- Monitoring and control is concerned with the day-to-day review of the deployed wireless systems to assure smooth customer services. Of particular importance are the wireless management platforms that provide answers to the following questions:
 - Are there any failures in the system?
 - Are there any performance bottlenecks?

- Is security being properly enforced?
- Are changes in the system being propagated uniformly?
- Organizing and staffing concentrates on the important issues of organizing and staffing the wireless projects. Questions include:
 - What type of organizational structure will support the wireless projects?
 - Can mobile virtual teams help?
 - Can the next generation of real-time enterprises be managed through mobile computing?



The Agenda

- Strategic Planning
- Capability Evaluation and Development
- Monitoring and Control

13.2 Strategic Planning

The purpose of strategic planning is to evaluate new business opportunities, renovating company products and services, and streamlining the business processes. It is important to take an m-business perspective because m-business combines wireless with Internet and e-business [Kalakota 2002]. Thus m-business goes beyond e-business to take advantage of the wide range of mobile (in many cases handheld) devices that are connected through wireless networks. Thus:

$$\text{M-Business} = \text{E-Business} + \text{Wireless Networks} + \text{Mobile Devices}$$

But launching m-business initiatives can be an expensive undertaking. For this reason, it is important to take a strategic look to identify the mobile applications that are vital to the firm's m-business initiatives.

13.2.1 Business Strategy Analysis

13.2.1.1 Business Strategy at a Glance

Simply stated, strategy is a game plan to win. The objective of business strategy analysis, mobile or not, is to define and refine the type of business activities an enterprise should undertake to succeed. Specifically, an m-business strategy is established to define a vision of critical mobile information services with a solid business model. For example, UPS uses wireless technologies as a competitive edge to track shipments of items in a worldwide network.²

But how are business strategies developed? A common approach is based on two factors: products (existing and new) and customers (existing and new). The basic idea is presented in Figure 13-2. To be successful, companies need to consider all four cells of Figure 13-2.

² *Information Week Magazine* (www.informationweek.com) – June 2001

Naturally, existing products for existing customers need to be strengthened – this is a firm’s base. However, firms cannot survive without introducing new products and attracting new customers. It is also desirable to expand the existing customer base by selling existing products to new customers and also to “upsell” by introducing new products to existing customers. The riskiest undertaking is when you are exploring new horizons by introducing new products for new customers. The vast space of wireless presents many opportunities for new products and customers for many companies. The challenge faced by companies is to understand and exploit the confluence of trends in customers (e.g., the speed and reliability of service demanded by the customers and the appeal of mobile services), organizational trends (e.g., outsourcing and continued innovation in mobile group communications), and technology trends (e.g., integration of mobile services with back-end systems, broadband wireless networks, and component-based software for mobile applications).

	Existing Products	New Products
Existing Customers	Strengthen Current Situation	Upselling
New Customers	Expand Customer Base	Explore New Horizons

Figure 13-2: Establishing Strategies Based on Products and Customers

The main question is: which cell should a company focus on? A variety of models have been developed that help in this area. Among the best-known models in this category are the Porter Models that are briefly reviewed here.

Porter Models were introduced by Michael Porter, first in 1980 and then later in 1985 [Porter 1980, 1985]. The first model, known as the competitive force model, is used most heavily. Porter’s basic idea is that companies must contend with five competitive forces: the threat of new entrants, the bargaining powers of customers and buyers, the buying power of suppliers, substitutes for your products and services, and the intensity of rivalry among competitors (see Figure 13-3). He then proposes three strategies to succeed: differentiate your products and services, be the lowest-cost provider, and find a niche. Five years after this very simple yet elegant model, Porter proposed a Value Chain model suggesting that to be successful, companies must add value at every step of creation, development, sale, and after-sale. This model also became very popular.

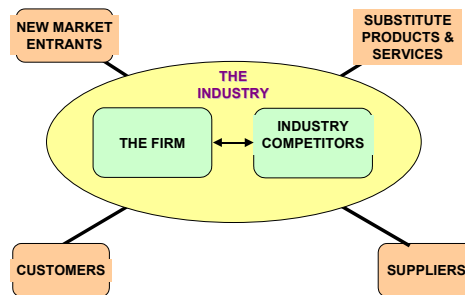

Figure 13-3: Porter’s Competitive Force Model

Let us use the following examples to illustrate Porter's Competitive Force Model.

- The US Post Office services, circa 1980, had no competition. Federal Express was a new market entrant that came up with overnight delivery services and became a competitor to the Post Office. Other entrants such as UPS also became competitors to the Post Office. While positioning to compete with the new entrants, the Post Office had to face a substitute service – email. As we all know, email is a substitute for paper mail and even telephone calls. Thus the new entrants and the substitute services cannot be ignored.
- Rand McNally has been printing maps until 1916 and has been the leader in maps ever since. The company publishes a very successful *Rand McNally Road Atlas* that has sold 150 million copies. However, as the digital economy developed at the beginning of the 1990s, Rand McNally's management did not understand the full impact of the new Internet and other computer-related developments. In particular, new startups such as MapQuest came out of nowhere and became a chief competitor in the new online map environment. New management was brought in to create a website (RandMcNally.com) to put Rand McNally maps and address-to-address driving directions on the Web. Despite several attempts at gaining the online map and end-to-end directions business, Rand McNally has a long way to go to catch up to its more digital-savvy competitors. Thus new entrants such as MapQuest, armed with substitute products (online maps) and additional services (e.g., online directions) have successfully competed with a market leader. Obviously, the changes in customer attitudes (many customers are comfortable with the idea of printing maps and directions online) have helped the new entrants.

13.2.1.2 Establishing an M-Business Strategy

In the highly competitive and fluctuating wireless market, companies need to continuously watch out for new entrants and substitute products and themselves develop new products to stay in business. Typical questions asked in m-business planning by a company are:

- **How will the customer benefit from m-business?** Instead of following the m-business hype, it is important to know exactly what the customers will be able to do with mobility that they cannot do right now.
- **How will the firm benefit from m-business?** A successful mobility strategy also must focus on the value to the company and pinpoint what will the company be able to do with mobility that it cannot do right now.
- **Is there a market for what we are building?** Even if m-business can benefit the customers, will they buy what we offer; and how big is the market? It is possible that the new services may be too expensive or cumbersome, as evidenced by the Iridium disaster.
- **What value does m-business provide?** The value chain to deliver m-business services to the customers must be carefully examined. For example, if the customers of an m-service are supposed to be students, then it is a good idea to tailor the service in a fashion that provides maximum value to the students.
- **How will we make the money?** It is crucial to understand the economics of new services and to develop a thorough cost-revenue model. It is not enough to generate sales and revenues if it costs much more than the money being made.
- **Are we doing the right things?** It is important to know if the wireless technologies will help the company to reshape its future – will mobile services provide a competitive edge, will they help to administer the business objectives, and will they enable us to adapt to unexpected changes?
- **Are we doing things right?** Are we minimizing the unit costs for each mobile service, and is the value of mobile service worth the cost?
- **Are we heading in the right direction?** Are we listening to our customers and paying attention to their service needs, or are we pushing the new technology without paying attention to them?

- **What are the services we are good at and what are the services we need to improve/discontinue?** Are we sinking too much money into older technologies? How confident are we about the new technologies?

It is the responsibility of management to develop and present a clearly defined and doable vision. Unfounded visions and too many visions (“vision of the day”) cause serious problems. Announcing a vision is not enough; continued and visible support from management is essential for the success of a strategy. One possible approach to achieve these objectives is to get the information technology and wireless network experts involved in strategy formation. These experts can help in making the vision realistic and then work as agents and supporters during the implementation stages.

It is beyond the scope of this book to discuss business strategies in detail. The following sidebars summarize the main ideas from a few of my favorite papers on business strategies. The sidebar “Porter’s Thoughts on Internet Strategy” summarizes Mike Porter’s views on the good and bad news associated with the use of Internet for business strategies. The sidebar “How Home Depot Created a New Market” shows how Home Depot succeeded in a very competitive marketplace by addressing the needs of homeowners. The sidebar “Disruptive Technologies – When NOT to Listen to Your Customers” presents a very important view by Christiansen on how some companies fail because they keep listening to their existing customers. Several books, such as Kalakota [2000], Sawhney [2001], and Whyte [2001], and journals/magazines such as the *Journal of Business Strategy*, *Harvard Business Review*, *Sloan Management Review*, *CIO Magazine*, and *Information Week*, should be consulted for detailed insights. In addition, consulting firms such as IDC (www.IDC.com) have published a series of reports on e-business strategies.

Porter’s Thoughts on Internet Strategy

Some argue that the Internet renders strategy obsolete. Michael Porter contends that the opposite is true. In fact, the Internet weakens profitability and lowers entry barriers for newcomers; thus it is even more important for the companies to distinguish themselves through strategy. The winners, according to Porter, will be the companies that view the Internet as a complement to the traditional ways of competing.

The Internet is a powerful enabling technology that can be used, wisely or unwisely, as part of any strategy and in any industry. The main question facing the companies is how to deploy the Internet. In general, the companies that succeed will be the ones that use the Internet as a complement to the traditional ways of competing, and not those that separate their Internet initiatives from their established operations. Traditional companies as well as dot coms can benefit from the Internet by making it a tool for distinctive strategies. Thus the Internet makes strategies more essential than before.

Most of the Internet benefit should be measured in terms of the economic value it creates in the real companies. Economic value is the gap between price and cost and reflects the profitability of a company. Creating revenues, reducing expenses, and even attracting new customers are not evidence of economic value. Reducing cost, for example, does not show profit if you have to reduce prices dramatically to stay competitive. It is not good to point to the success of Internet tool providers as a sign of success. In fact, in many cases, tool developers do quite well in periods of experimentation even though the experiments themselves are not very successful.

To determine how the Internet creates economic value, Porter suggests two fundamental factors: a) the industry structure, which determines the profitability of the average

competitor; and b) sustainable competitive advantage, which allows a company to outperform the average competitor. For example, the Internet has opened new markets for potential profits, but it is difficult to maintain a competitive edge because everyone else can also enter the new marketplace.

Porter's paper goes through a detailed analysis of the Internet regarding these two factors and lists six principles of strategic positioning:

- Start with the goal of long-term profitability.
- Deliver a value proposition that is superior to the competition.
- Provide a distinctive value chain; i.e., provide value at every step of design, manufacturing, distribution, and sales.
- Be willing to give up some features of products and services in order to provide added values in other ways; i.e., tradeoffs must be part of the strategy.
- Define how all the products and services of a company fit together.
- Provide continuity of direction; i.e., do not disrupt services and products without giving them a fair chance.

Source: M. Porter, "Strategy and the Internet," *Harvard Business Review (HBR)* (March 2001).

How Home Depot Created a New Market

Home depot has revolutionized the do-it-yourself market in North America. It has become a more than \$25 billion company that has created 130,000 new jobs in more than 1000 stores across the United States. Home Depot succeeded in creating a new market by converting homeowners into do-it yourselfers. The main idea is that home owners do not like to wait for contractors to arrive at odd hours and charge top dollar for jobs that are not well done. Instead the homeowners would like to do things themselves, if possible. Home Depot enabled these homeowners to do their own thing and hired trained staff, including many ex-contractors, to help the customers in buying the right products and to give "how to" advice.

Source: W. C. Kim and R. Mauborgne, "Creating a New Market Space," *HBR* (Jan-Feb, 1999).

Disruptive Technologies – When NOT to Listen to Your Customers

Many leading companies fail to stay at the top of their industries when markets or technologies change. IBM dominated the mainframe market but missed the minicomputers by several years even though minicomputers are much less sophisticated than mainframes. Digital Equipment Corporation (DEC) dominated the minicomputer market due to its Vax machines but missed the smaller PC market. Apple computers led the user-friendly computers but lagged 5 years behind its competitors in bringing its portable computers to market.

The main reason for many of these failures is that the companies stay too close to their existing customers while new customers and products are emerging. For example, Xerox built large copying machines for copying centers. When asked, the copying centers did not see any need for smaller copier machines. Similarly, IBM talked to its mainframe customers to see if minicomputers and desktops could be of use to them – IBM found that these customers wanted more mainframe features instead of smaller machines.

Managers must be aware of the disruptive technologies that do not initially meet the needs of their existing customers. Disruptive technologies such as small copying machines in the era of big copying machines must be looked at as new products/services for new customers.

Source: J. Bower and C. Christiansen, “Disruptive Technologies: Catching the Wave,” *HBR* (February 1995).

13.2.2 Analyzing Business Processes and Business Workflows

After examining business strategies, it is a good idea to analyze the business processes and the workflows between them, because many mobile applications are initiated as a result of such analysis. For example, handheld devices are used frequently to streamline the physical inventory checking processes. Business process re-engineering (BPR) is at the heart of such analysis. A very brief overview is presented here for completeness; see the sidebar, “Business Process Re-engineering Sources of Information” for additional information. The main idea of BPR is to determine what business processes (BPs) are needed to conduct a business activity, why they are needed, and to redesign the BPs from the ground up instead of simply automating existing tasks. Wireless systems can play a crucial role in BPR to improve the performance of a business and to cut costs.

A business process is “a set of logically related tasks performed to achieve a defined business outcome” [Davenport & Short 1990]. The business processes in this simple case are the activities that you and the store personnel do to complete the transaction. Examples of other business processes include purchasing books online, ordering clothes from mail order companies, requesting new services from your ISP, developing new products and services, administering the delivery of furniture to customers, initiating a new line of software products, constructing a new office building, etc. The business processes are typically pictured as a set of squares with some feedbacks as shown below.

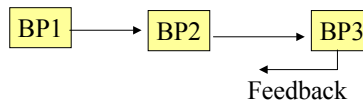

Figure 13-4: Simple Business Process (BP) Flow

Improving business processes is crucial for businesses wanting to stay competitive in today’s marketplace. Companies are continually forced to improve their business processes because the customers demand better products and services. While processes can be improved continuously (“business process improvement”), BPR relies on a radical change by assuming that the current process is irrelevant and does not work. BPR forces designers to start over with a clean slate. This perspective enables the designers to disassociate themselves from today’s process and focus on a new process. From a mobility point of view, the main idea is to create a vision for the future that includes mobility, and to design new business processes that take advantage of mobility as much as possible. Given a vision of the FMO (future method of operation), you can then create a plan of action based on the gap between FMO and PMO (present method of operation). Based on this gap, you determine the capabilities needed to fill the gap and then implement your solution approach, as discussed in later sections (sections 13.3 and 13.4).

Workflow between business processes is the main approach used in BPR. Simply stated, workflow is concerned with automatically routing the work from one process to the next — it defines the operations that must be performed, from the origin of work to its completion. Workflow, in essence, represents the “business choreography” between business entities — i.e., the steps required to complete a business process and the rules which determine what steps should be performed when. Consider, for example, the process of getting a purchase order (PO) approved for equipment that costs more than \$100K. In this case, the PO will be shuffled between various managers for different levels of approvals. Figure 13-5 shows a simplified view of the PO approval process. In some cases, the approvers may be on vacation and might have delegated the approving authority to someone else.

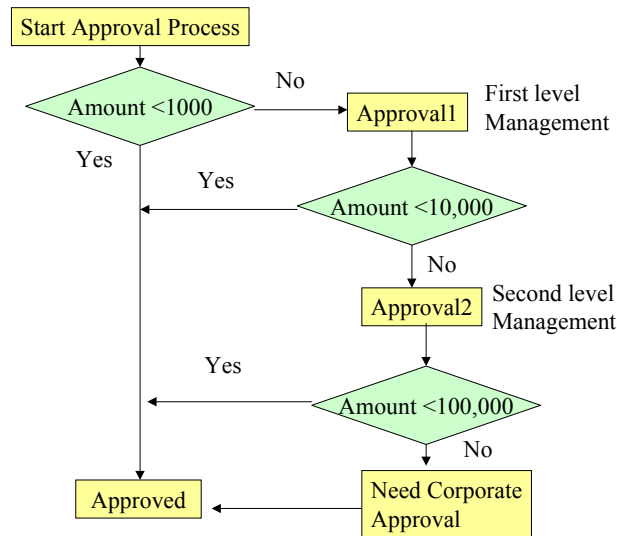

Figure 13-5: A Simplified View of Workflow for Loan Processing

Workflow management system (WMS) is the software that enables improvements in business processes through automated workflow. Specifically, a WMS:

- facilitates modeling of workflow process and its constituent activities
- routes work in the sequence as specified in the process model
- provides access to the data and documents required by the individual work performers
- tracks all aspects of process execution

These functions, shown in Figure 13-6, are the foundation of WMSs — many are commercially available from suppliers such as IBM, HP, and others. For additional information, see the sidebar, “Workflow Management Sources of Information.”

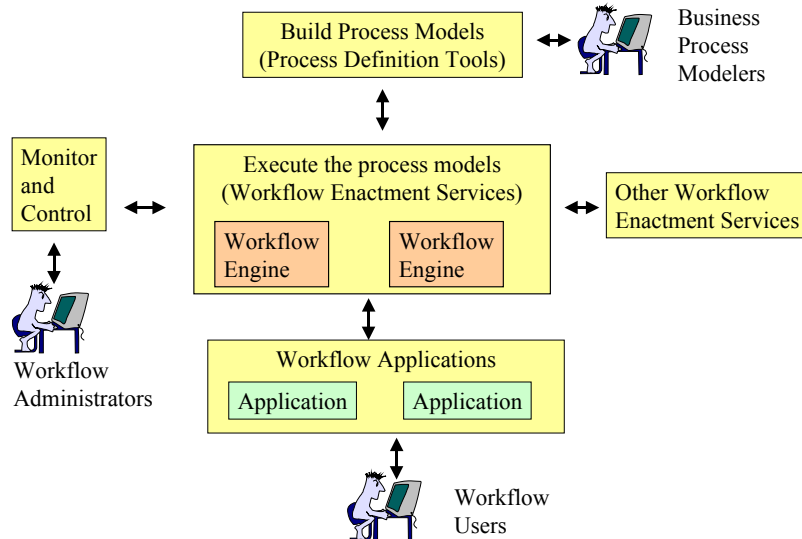

Figure 13-6: Conceptual Model of a Workflow Management System

Business Process Re-engineering – Sources of Information

Websites

- <http://www.brint.com/papers/bpr.htm> – BPR (redesign) overview paper
- <http://www.prosci.com/> – BPR online learning center – has free reports and tutorials, and books for sale.
- <http://www.brint.com/BPR.htm> – many articles and tutorials
- <http://www.waria.com/> – WARIA – Workflow And Reengineering International Association (publishes a handbook)

Books

- Hammer, M. and Champy, J. *Reengineering the Corporation: A Manifesto for Business Revolution*. Harper Collins Publishers, 1993.
- Jacka, I. and Keller, J. *Business Process Mapping: Improving Customer Satisfaction*. Wiley, 2001.
- Carr, D. and Johansson, H. *What Works And What Doesn't In The Reengineering Process*. McGraw-Hill, 1995.

Workflow Management – Sources of Information

- Workflow Management Coalition (WFMC) website (www.wfmc.org)
- Workflow And Reengineering International Association (WARIA) website (<http://www.waria.com>)
- *The Workflow Handbook 2001*, published by WARIA in association with WFMC, Layna Fischer, ed., Oct. 2000.
- *Workflow Comparative Study*, 2001 Edition, published by WARIA.
- *Information Systems Frontiers Journal*, Special Issue on Workflow Automation, Vol. 3, No. 3, Kluwer Publications, Sept. 2001.

13.2.3 Mobile Application Identification and Selection

In this step the business strategy established above is translated into specific mobile application systems that will support m-business. The goal is to clearly identify the application systems at the enterprise level which can satisfy the mobile services strategy of an enterprise. For example, this step would identify the mobile ERP applications, mobile customer relationship management systems, m-commerce systems, m-portals, and mobile office applications (e.g., SMS) to satisfy the vision of m-business.

The result of this step is a matrix that captures the mobile applications A1, A2... An that are needed to support the business processes BP1... BPn identified in strategic analysis. How to identify the complete set of business processes (BPs)? Here is a suggested approach:

- List all BPs that support the B2C, B2D, B2E, and other business interactions.
- To make sure that you do not get thousands of BPs that cover trivial daily activities, keep your focus on the enterprise level and on the activities that are vital to your business. According to Rockart's Critical Success Factors methodology [Rockart 1982], the focus should be on those processes that are *critical to the success of your business*.
- Reduce duplication by clustering similar BPs into one. For example, if the same BP is used for customers as well as business partners, then it is better not to have two different BPs.
- It is a good idea to question, eliminate, and restructure business processes to improve organizational efficiency. The whole idea of business process re-engineering is to streamline and eliminate unnecessary, outdated, and redundant BPs.

In reality, one or many applications may be needed to support a given business process, and a given business process may need multiple applications.³ For example, a customer relationship management application may support many business processes such as purchasing, marketing, and payment. Similarly, a purchasing business process needs support of many applications such as order processing software and inventory management software. This is a good place to bring the mobility angle into the picture.

An interesting approach to quickly build models of this nature is based on e-business patterns [Adams 2001]. These patterns capture the common BPs used in e-business and can be used to capture the key enabling applications. Figure 13-7 shows a high-level view of a common e-business pattern. This pattern shows the main C2B, B2B, and B2E (Business-to-Employee) processes with their interrelationships at high levels. The mobile applications of value are displayed in this diagram through color codes – lighter colors show mobile applications.

Given this high-level pattern, the impact of introducing mobile applications can be understood at a high level. For example, mobility appears to be introduced in customer/reseller and partners/supplier relationships – a viable business strategy. The internal systems are largely untouched but may have to be modified to deal with mobile applications. This view, as we will see in the next section, can also lead to a high-level architectural sketch that introduces the role of technologies (see Figure 13-8). In addition, more detailed views can be developed.

³ It is important to differentiate a business process from an application. A business process is a business activity that may or may not be automated, while a (business) application is the *software* that supports a business process. For example, inventory management is a business process that can be done manually in small businesses (i.e., count the items on the shelf and write them down on a piece of paper). An inventory management software package is an application that can be used to do inventory management.

Table 13-1, for example, shows a few applications that could support high-level business processes such as financial management, marketing, purchasing, and inventory management. This table also shows where mobility support is needed and if mobility will be an add-on service to existing applications or will have to be developed as a completely new service. Tables of this type can be extremely revealing and can lead to sound decision making. For example, this table indicates that in most cases, mobility is an add-on feature to existing applications.

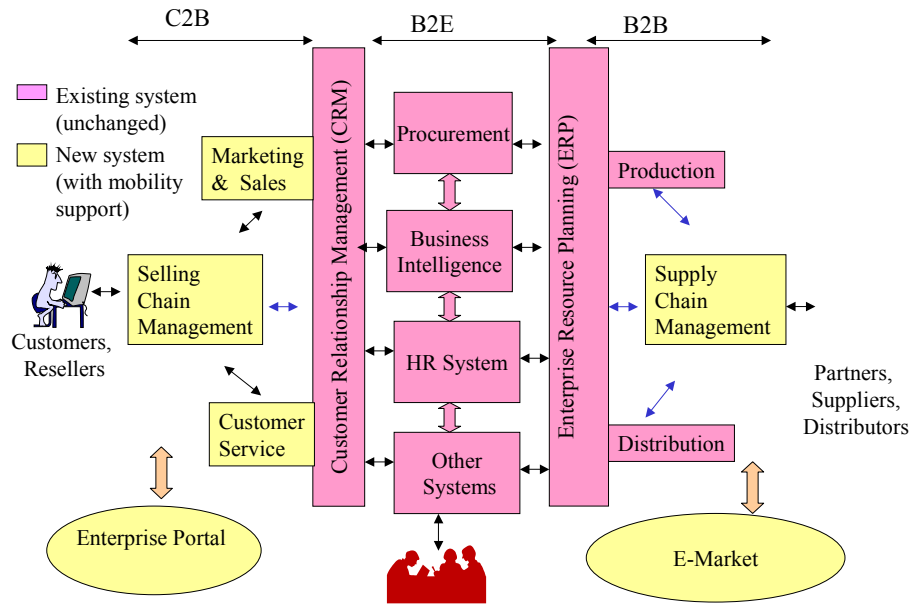

Figure 13-7: A High-Level e-Business Pattern

Table 13-1: Mobile Applications to Support Business Processes

	Business Process1 (Financial Management)	Business Process2 (Purchasing)	Business Process3 (Inventory Management)	Business Process4 (Marketing)
Application 1 (Website)				Mobility as a an add-on (M-Portal)
Application 2 (Customer Relationship Management System – CRM)				Mobility as a an add-on (M-CRM)
Application 3 (Online Purchasing Systems)		Mobility as a an add-on service (M-Commerce)		
Application 4 (Supply Chain Management System – SCM)			Mobility as a new service (e.g., location service for M-SCM)	

Note: Blank cells indicate that mobility support is not needed according to the company



Time to Take a Break

- ✓ • Strategic Planning
- Capability Evaluation and Development
- Monitoring and Control

13.3 Capability Evaluation and Architectural Vision

Strategic planning basically identifies the applications (A_1, A_2, \dots, A_n) needed to support the business strategy. The next activity is to evaluate the capabilities (wireless infrastructure, for example) needed to support the outcome of the strategic planning. The key questions that drive this activity are:

- What are the basic building blocks of the solution and how will they fit with each other and with the existing systems? This question is at the core of architectural analysis and is examined in Section 13.3.1.
- What technical capabilities are needed to support the architecture, which ones do we already have, and what should we do to acquire the new ones? This question guides the discussion in Section 13.3.2.
- Will the new systems have the capacity to handle the traffic expected? This question is addressed in Section 13.3.3.
- What will it cost to provide the new capabilities? This question is the focus of Section 13.3.4.

13.3.1 Architecture Analysis to Support Mobility

As stated in Chapter 11, an architecture captures a) the building blocks (components) of a system, b) functional specification of what these components do, and c) the interconnections and flows between the components. We discussed various aspects of architectures extensively in Chapter 11. For an m-business initiative, the architecture that combines applications (old plus new) and also includes a high-level view of the enabling IT infrastructure, included wired and wireless networks, may look something like a configuration shown in Figure 13-8. This configuration is in fact a refinement of the technology-independent pattern shown in Figure 13-7. In this configuration, the new applications reside in the middle tier that is accessed directly from the users. The existing back-end and external applications are accessed through some type of back-end integrator, in effect an EAI (Enterprise Application Integration) platform as discussed in Chapter 11.

Once a high-level architectural sketch of this nature has been developed, then the exact technical capabilities needed can be identified. In addition, to translate an architectural sketch into a working solution, you have to decide if you are going to purchase, develop in-house, rent, or outsource what you need. We will look at these decisions in Section 13.4.

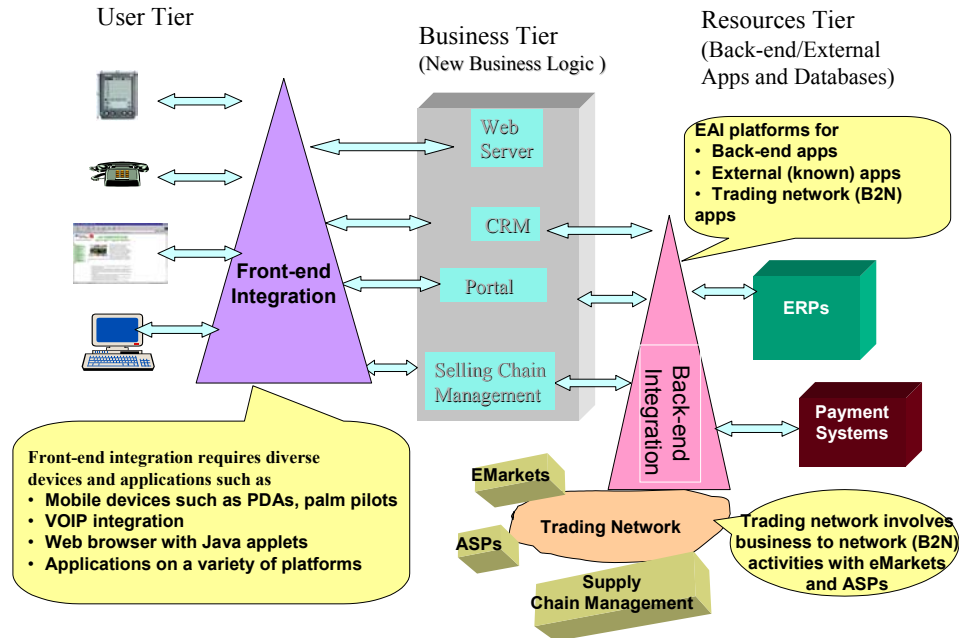

Figure 13-8: Solution Architecture that Combines New, Old, ASPs, etc.

13.3.2 Wireless Infrastructure Planning – Identifying Technical Capabilities

The question that drives this step is: what technical capabilities are needed to support the architecture, which ones do we already have, and what should we do to acquire the new ones? The focus is on pinpointing the wireless infrastructure needed to implement the architecture identified previously. Examples of the wireless infrastructure are wireless networks (cellular networks, wireless LANs, wireless local loops, cordless systems, satellites) and the mobile computing platforms such as Oracle9iAS Wireless and Nokia’s WAP Server. This step also translates the technology-independent model displayed previously into a technology-specific model. Wireless infrastructure has to naturally integrate with other IT infrastructure that may already exist. Examples of important “other” IT infrastructure components are the intranets which host corporate private resources; web servers and proxies that reside in the middle tier; application servers to support sophisticated applications; factory networks which connect many manufacturing devices to cell and area controllers, and “extranets” which connect many business (e.g., healthcare industry participants).

Specifically, the main infrastructure capabilities (middleware, network services, local computing services) needed to support mobile applications must be carefully examined. Figure 13-9 and Figure 13-10 show different views of an online purchasing system where a cellular phone user accesses a purchasing system that in turn accesses a catalog. The real IT infrastructure is a complex combination of middleware and network services that reside on different computers that are interconnected through a network. Figure 13-10 shows a more realistic view of a mobile online purchasing system that is a refinement of the view presented in Figure 13-9. This view shows the wireless infrastructure components, in terms of a WAP implementation, that need to be planned and integrated with the back-end systems for communications over the wired Internet. We have discussed the individual components in previous chapters of this book.

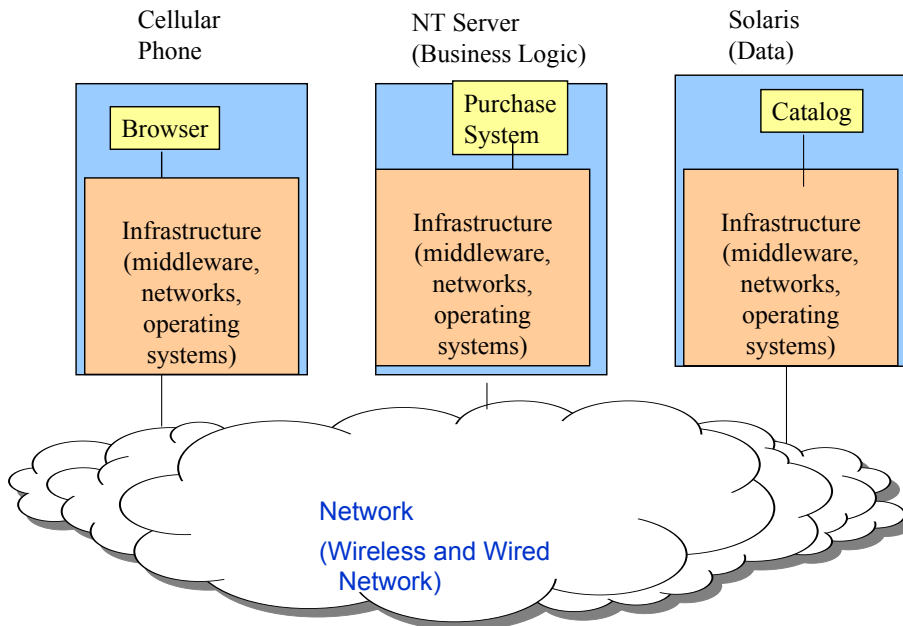

Figure 13-9: Simplified View of Infrastructure for a Mobile Online Purchasing System

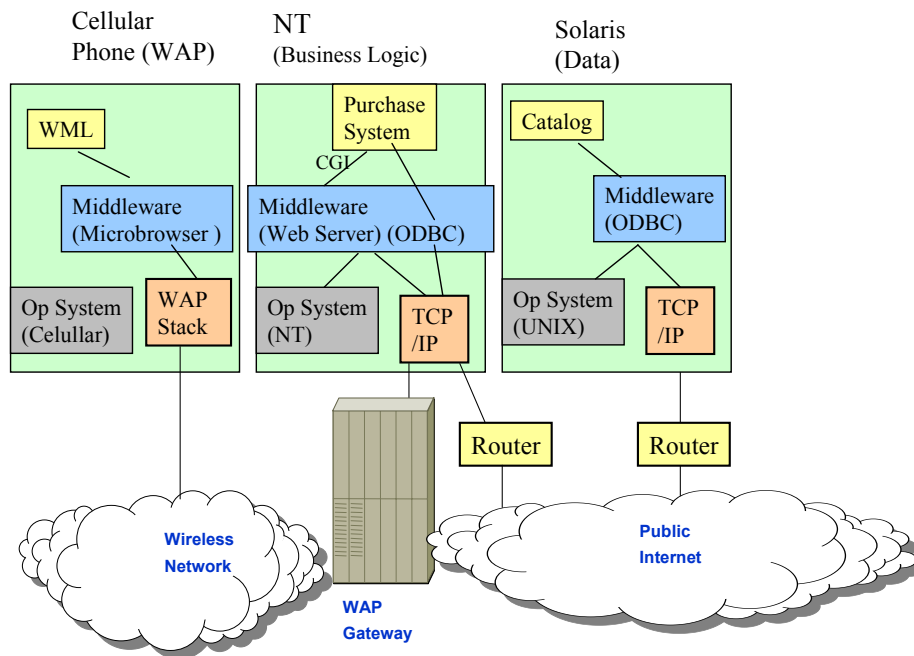

Figure 13-10: Detailed View of IT Infrastructure

The IT infrastructure becomes increasingly important as you iterate through the system life cycle (i.e., planning iteration only concentrates on high-level issues that could be “show stoppers,” while the first release must go through detailed considerations such as the exact version of middleware needed). The details depend on the type of applications being engineered/re-engineered. For example, legacy data access from a PDA requires a different type of infrastructure than a wireless LAN-based application. Finally, the capacity panning

and traffic engineering issues, discussed next, need to be considered to optimize mobile services by minimized queuing delays, handoff problems, call drops, and others.

13.3.3 Capacity Planning and Traffic Engineering

13.3.3.1 The Basic Principles

Given an architectural sketch of a solution that articulates the technical details of various components, the question is: how many users can it handle adequately – is it good for 100 or 100,000 users? This question is typically addressed through capacity planning. Capacity planning has been an active area of work in computer-communication systems for several years [Menasce 2000, Yu-Lee 2002]. It is beyond the scope of this book to give a complete coverage of this topic; instead our interest is in examining capacity planning and traffic engineering in wireless LANs and cellular networks. Let us review the basic principles based on response time estimation.

Simply stated, response time of a system is the elapsed time between request submission and completion. In the simplest case, the total response time RT of a system, wireless or not, is given by the sum of all processing and queuing delays: Without queuing, R, the response time, is given by

$$R = \sum_i N(i) * S(i) \dots\dots\dots (1)$$

where S(i) = time needed for completion of service i, N(i) = number of times service i is needed, and service i represents any activity handled by a system. S(i) and N(i) can be easily measured through prototyping. In these formulas, * is used to indicate multiplication. Example 1 illustrates the usefulness of this simple formula. This formula can be used to calculate lower bounds (best case) of response time estimates. Given two sites M and N where a database server D can be allocated, the analyst can compute the response times R for the two allocations and choose the site with minimal response time.

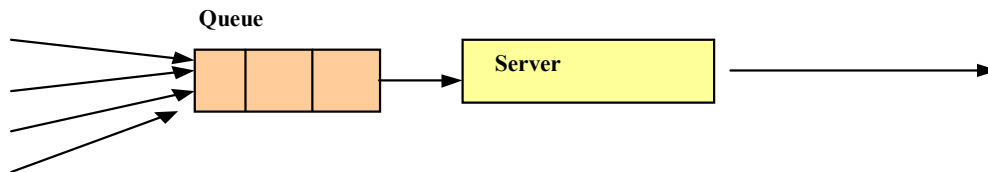

Figure 13-11: A Conceptual View of Queuing System

Although the best case estimates are a good starting point, they ignore the impact of queuing on response time calculations. Queues are formed due to two reasons: the device providing the service may be busy or it may be locked by another activity. The first condition is an indication of workload (too many services requested) and the second condition is a result of resources being reserved (e.g., a file being updated) by one activity. In this section, our primary focus is on queuing due to workload. We need to introduce another parameter, A(i), to handle queuing. A(i) = arrival rate of requests for service i. For example, if 10 workstations send 5 queries per hour to a database server, then A(i) = 50 per hour for the database server.

The following formula shows utilization U(i) of a database server i:

$$U(i) = \text{server } i \text{ utilization} = A(i) * S(i) \dots\dots\dots (2)$$

A rule of thumb used in queuing calculations is that $U(i)$ should be kept below 0.7 to avoid queuing. The theoretical foundation for this rule of thumb is the following well-known **Little's formula** [Kleinrock 1976]:

$$\text{Queue length at server } i = Q(i) = U(i)/1-U(i) \quad \dots\dots\dots (3)$$

Where $Q(i)$ shows the number of customers in the system, including the one being served. Thus $Q(i)=1$, if $U(i)=0.5$; $Q(i)$ reaches infinity if $U(i)=1$. Table 13-2 shows the impact of utilization on system performance. The key point is that U must be kept below 0.5 to keep queuing low and thus to run the system at optimal performance. If U is too high, then you could do the following to improve performance:

- Reduce service time by using faster servers.
- Reduce arrival rate A by adding more servers.

Table 13-2: Impact of Utilization on Queue Length and System Performance

Utilization U	Queue Length $Q=U/1-U$	Impact on System Performance
0.1	0.1	No queuing – system should perform optimally
0.5	1	On average, one customer in queue, including one being served – some delays expected
0.7	2.3	On average, two customers. Response time may double
0.8	4	Response time could be four times, causing serious performance problems
0.9	9	Response time could be nine times, causing disastrous performance problems
1.0	Infinite	Forget it

The basic assumptions of the Little's formula are:

- Arrivals at the server are independent of each other.
- Service times are independent of each other.

It is not necessary for the users to know that these two assumptions are based on stochastic processes and queuing theory. For example, these arrival and service time patterns are called Poisson and Exponential distributions, respectively, in stochastic processes. Poisson arrival rates and Exponential server times are referred to as Markovian behavior in queuing systems.

The net effect of queuing is that the service time increases due to queuing. The service time $S(i)$ is replaced with $S'(i)$:

$$S'(i) = \text{service time at server } i \text{ after queuing} = S(i) + S(i)*Q(i) \quad \dots\dots\dots (4)$$

So far we have focused on queuing for a single server. In most practical situations, a queuing network is formed where output of one server becomes an input to another server. Jackson's Theorem [Kleinrock 1976] shows that the following very useful results apply as long as Poisson arrival and Exponential server assumptions hold at each server in the queuing network.

- Each server can be treated independently.
- Arrival rate at a server is the sum of all arrivals from all sources.

Jackson's theorem is used heavily because it applies to stochastic routing, in which a message is routed to server i with probability $p(i)$. In fact, even when the Poisson arrival and Exponential service time assumptions are not satisfied, this formula is used because there is

no other straightforward method for the analytical calculations of response times in queuing networks.

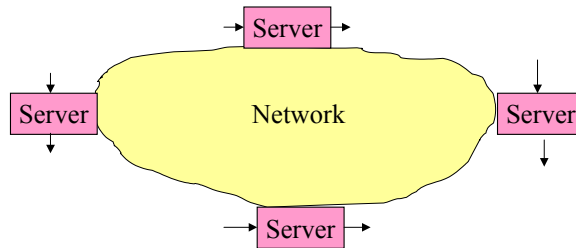

Figure 13-12: A Queuing Network System

Response Time Estimation: The Key Points

- Response time can be roughly estimated in terms of three easily observable parameters :
 - S = Service time of a device
 - A = Arrival rate at the device
 - N = the number of devices in the network
- Utilization U, simply given by $A \cdot S$, is a good indicator of server congestion. U should be kept at less than 70 % to avoid excessive queuing.
- In a network of devices, the device with the largest U is the bottleneck.
- U can be reduced by decreasing the arrival rate A, decreasing the service time S, or both. For example, in the customer file example described in Tables 2.5 and 2.6, A can be reduced by putting the customer file at more than one computer and S can be reduced by purchasing a faster disk.

13.3.3.2 Wireless LAN Capacity Planning and Traffic Engineering

WLANs in a building need to be carefully planned to:

- Choose the most appropriate WLAN technology that can handle the current and future workload
- Determine the number of access points (APs) to be installed
- Design the topology of the LANs based on performance and security considerations

Although most businesses are choosing 802.11 WLANs, and rightfully so, there is still some debate about choosing within the 802.11 family. In other words, should a company use 802.11a, 802.11b, or the 802.11g WLANs? At present, 802.11b, also known as Wi-Fi, LANs are most popular, with their 11 Mbps data rate and 100 meter coverage. However, the newer 802.11g LANs are also commercially available with data rates up to 54 Mbps. But 802.11a also delivers the same data rate of 54 Mbps, so 802.11a and 802.11g are fierce competitors. To decide between the two, the differences between the two need to be examined (see Table 13-3). The major difference is that 802.11a operates in the 5GHz frequency band that is less-crowded than the 2.4 GHz band. However, the distance range of 802.11a is lower than 802.11g because higher frequencies have shorter ranges (the loss is higher at higher frequencies). Because of the shorter distance, the cost of 802.11a could be higher because you need more access points for the same area. A major limitation of 802.11a is that it is not compatible with 802.11b, thus a device equipped with an 802.11b or 802.11g card cannot interface directly to an 802.11a access point. This situation can be taken care of by multi-mode NICs (Network Interface Cards) that are becoming commercially available.

What should you do if you want to use higher data rates in the 54 Mbps range? Basically, you should use 802.11a if you are starting from scratch but use 802.11g if you have a large embedded base of 802.11b LANs.

Table 13-3: 802.11a versus 802.11g

Factor	802.11a	802.11g	Comments
Data rate	54 Mbps	54 Mbps	Competitors for same data rates
Frequency	5 GHZ	2.4 GHZ	802.11a shorter range (needs more AP) 802.11a has less interference because it operates in 5GHz band
Compatibility with Wi-Fi (802.11b)	Not compatible	Compatible	Need new access points if an 802.11b LAN is to be converted to 802.11a.

To determine the number of APs, the main criteria are the distance covered and the number of users. For example, 802.11b and 802.11g APs cover 100 meters while 802.11a APs may only cover 10 meters. Thus more APs would be needed in an 802.11a installation. To determine the number of users per AP, the Little’s formula discussed previously can be used. Consider, for example, the situation of an 802.11b LAN where each workstation generates 1 message per second and each message is 1000 bytes long (about a screen). How many workstations (laptops) can be supported on this LAN?

Assuming 10 bits per byte for communications and that an 802.11b AP can provide a data rate of about 10 Mbps (we are assuming a data rate slightly lower than 11 Mbps because in most practical cases, 11 Mbps is the maximum):

$S = \text{service time per message} = 1000 \times 10 / 10,000,000 = .001 \text{ sec}$
 $A = \text{arrival rate} = 1 \text{ per second for one workstation}$
 $U = A \times S = 1 \times .001 = .001$ (Virtually no queuing according to the Little’s formula discussed previously)
 For 100 workstations with similar traffic, $A = 1 \times 100$, $U = 0.1$ (still OK)
 For 100 workstations with color graphic data where the message is 40 times bigger
 $S = 40 \times 10000 / 10,000,000 = 0.04 \text{ sec}$ and $A = 100 \text{ per second}$
 $U = 100 \times .04 = 4$ (too high, forget it)

For 15 workstations: $U = 0.6$. This may still be too high for an 802.11b LAN. Perhaps an 802.11g or 802.11a could be used instead. This could now significantly reduce S and thus reduce U .

Rough calculations of this nature that attempt to estimate U for each access point and then try to keep it below 0.5 for good performance are very beneficial in WLAN planning. For easier analysis, the arrival rate $A = N \times M$ where N is the number of users and M is the messages per second per user. Similarly, the service time $S = B/D$ where B is the average message size and D is the data rate. Thus, we get:

$$U = A.S = N \times M \times B/D \quad \dots\dots\dots (5)$$

This equation can be very helpful in designing a WLAN. For example, given N , M , and B , you can determine the minimum data rate that will keep $U < 0.5$. Similarly, by knowing M , B , and D , you can determine the maximum number of users N for good performance ($U < 0.5$).

To develop an overall LAN topology that performs well, the procedure may follow these steps. First, the utilization U of the shared devices (backbone networks, hubs, switches, access points) is calculated. Second, performance bottlenecks are identified by examining the devices with $U > 0.5$. Finally, the device with the largest U is identified as the main

bottleneck. Suppose that 5 devices are examined and yield $U = (0.2, 0.1, 0.7, 0.6, 0.8)$ for the 5 devices. Then three devices could cause queuing and the device with a U of 0.8 is a major bottleneck. Given this information, either new devices can be introduced or the network needs to be re-arranged for better load balancing. See Chapters 7 and 8 of Geier [2002] for details about topology designs and implementation issues for wireless LANs.

13.3.3.3 Cellular Network Capacity Planning and Traffic Engineering

In most cases, cellular network services are purchased by an organization to conduct their business. Thus the type of detailed capacity planning discussed for WLANs is not needed for WLANs. The following discussion, an abbreviation of discussion in Chapter 8, is here for the sake of completeness and to address the situations where organizations do have to design their own cellular networks.

Design of cellular networks, as discussed in Chapter 8, requires several considerations such as MTSO controlled calls, TDMA design, CDMA design, fading, handoffs, and traffic engineering:

- Mobile Telecommunications Switching Office (MTSO). An MTSO, also known as MSC (Mobile Switching Center), is essentially an end office to connect calls between mobile units. MTSOs control two types of channels between a mobile unit and a BS: control channels that are used for setting up and maintaining calls, and traffic channels that carry voice or data connection between users. Specifically, MTSOs handle mobile unit initialization, ongoing calls between PSTNs and cellular networks, and handoffs as the mobile units cross cell boundaries during an ongoing call. In addition to these activities, the MTSO is responsible to handle call blocking, call termination, and call dropping.
- Mobile Wireless TDMA Design Considerations. TDMA, the foundation of GSM, uses time slots for different users. A number of steps, described in Stallings [2002], are used to determine a TDMA time slot.
- 3G-CDMA Design Considerations. In CDMA, the users are differentiated through a code. Thus, decisions are made to handle handoffs efficiently and differentiate between overlapping signals.
- Mobile Radio Propagation Effects and Handoff Performance. Mobile communications introduce unique challenges that are not found in wired or fixed wireless networks. Signal strength, fading, and handoff performance are among the few challenges.

Let us briefly look at the cellular performance and traffic engineering issues. Most cellular systems are **blocking systems** where $L > N$ for N channels and L subscribers. Blocking systems raise performance questions such as: what is the average queuing delay; how many users can be supported without any queuing; and what is the probability that a call request is blocked? We can once again use the following two key parameters to get started:

$A(i)$ = arrival rate of calls to a cell i

$S(i)$ = service time (holding time) per call in cell i

The following formula shows utilization $U(i)$ of a cell i that supports N logical channels:

$$U(i) = \text{server } i \text{ utilization} = A(i) * S(i) / N$$

Once again, $U(i)$ of a cell i should be kept below 0.5 to avoid queuing. For example, consider a cell with 10 logical channels that receives 1 phone call per minute ($A = 1$), and the average holding time per call is 5 minutes ($s = 5$); then the utilization U of the cell is $5 \times 1 / 10 = 0.5$. This is not too bad. However, if the calls doubled, then $U = 1$. This is not good because the queue length (callers waiting to be serviced) is infinite.

13.3.4 Resource and Cost Estimation/Evaluation

The time, money, computing and human resources needed for construction of new mobile applications and conversion from the existing platforms to the future mobile computing platforms need to be estimated and evaluated in business settings. We first need to know if the transition between the existing infrastructure and the target infrastructure is cost-beneficial. For example, a major deterrent to the deployment of 3G cellular networks with their expected tangible benefits is the conversion cost from 2G to 3G. If it appears that the decisions made in the earlier stages are cost-beneficial, then the plan is finalized; otherwise one or more of the planning stages are iterated until a satisfactory configuration is finalized. In each iteration, the stages may be repeated with more details.

Better cost estimation is of key importance in this stage. Over the last 20 years, many cost-estimation techniques for information systems have been suggested. More attention is being paid at present to component-based software cost estimation [Lim 2003]. Despite a great deal of work, most cost estimates are based on heuristics and guidelines. Here are some guidelines:

- Assign the initial estimating task to the final designers and implementers of the system because they know all the details and the hidden costs.
- Delay finalizing the initial estimate until the end of a thorough study.
- Anticipate and control user changes.
- Monitor the progress of the proposed project.
- Evaluate proposed project progress by using independent auditors.
- Use the estimate to evaluate project personnel.
- Computing management should carefully study and approve the cost estimate.
- Rely on documented facts, standards, and simple arithmetic formulas rather than guessing, intuition, personal memory, and complex formulas.
- Do not rely on cost estimating software for an accurate estimate.

13.4 Development and Deployment Considerations

The capabilities and architectural sketches developed previously need to be translated to solutions that actually work and deliver services. To accomplish this, numerous business and technical questions such as the following need to be answered (see Figure 13-13):

- **Buy:** Should off-the-shelf packages be used to satisfy the requirements?
- **Build:** Should the needed capabilities be built from scratch (i.e., new user interfaces, new application code, new databases, new infrastructure components)?
- **Reuse:** Should existing capabilities be reused and expanded?
- **Rent:** Should the needed capabilities be rented on a monthly basis from a service provider?
- **Outsource:** Should the development and/or the operation of the needed capabilities be outsourced?

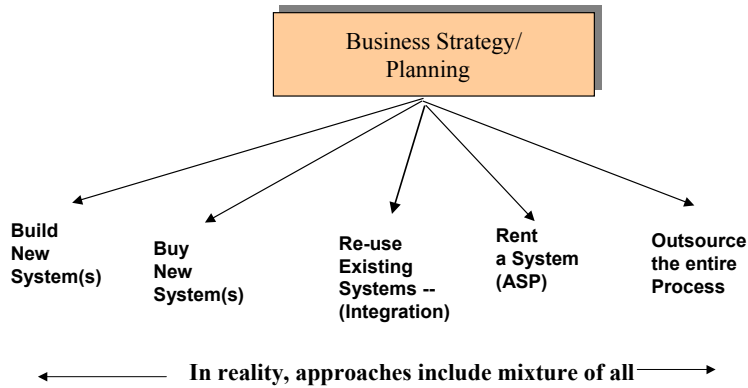

Figure 13-13: Options to Translate Strategies to Working Solutions

Table 13-4 attempts to capture the main tradeoffs between these choices. It can be seen that every option has some plusses and minuses (that is not surprising!). In reality, the decisions are mixtures. For example, you may want to build one application, buy another, and rent the third. The decisions could also vary depending on the type of capability needed. For example, a company may choose to build its mobile applications but outsource the installation and maintenance of the wireless infrastructure needed to run the applications. This analysis, as imagined, can be quite complex and lengthy. Our purpose is to highlight the key ideas by dividing the discussion in terms of the capabilities needed (applications versus infrastructure) and also in terms of in-house versus external (rentals and outsourcing) options. The specific questions that drive this discussion are:

- What are the application-specific tradeoffs in purchasing, developing in-house, rentals, or outsourcing? (Section 13.4.1)
- What type of considerations are important while embarking on in-house development and deployment of mobile applications? (Section 13.4.2)
- What needs to be done while acquiring and deploying the wireless infrastructure? (Section 13.4.3)
- What is the role of service providers in renting and outsourcing decisions? (Section 13.4.4)
- What is the role of wireless application service providers (ASPs) in renting and outsourcing mobile applications? (Section 13.4.5)

Table 13-4: Tradeoffs between Various Choices

	Plusses	Minuses
Buy off-the-Shelf	<ul style="list-style-type: none"> ▪ Quick acquisition ▪ Possibly robust if the tool is popular and used frequently ▪ Industrial-strength quality, documentation and support 	<ul style="list-style-type: none"> ▪ May be too large (has 50 functions when you need only 20) ▪ Support problems if the supplier goes out of business ▪ May not be customizable to your needs
Build Yourself	<ul style="list-style-type: none"> ▪ Can be built exactly as needed ▪ Can be customized as needed 	<ul style="list-style-type: none"> ▪ May take too long and cost too much ▪ May not be as strong as an industrial package
Re-use/Extend Existing System	<ul style="list-style-type: none"> ▪ Leverage existing investment ▪ May be quick and inexpensive 	<ul style="list-style-type: none"> ▪ May be too difficult to do in large and old systems ▪ May be "throwing good money after bad," i.e., expanding systems that should be retired

Rent from a Service Provider	<ul style="list-style-type: none"> ▪ Very quick ▪ No need for any technologies locally ▪ Can rent as long as possible 	<ul style="list-style-type: none"> ▪ Privacy and security concerns ▪ May not be able to upgrade as needed
Outsource Development	<ul style="list-style-type: none"> ▪ Can be inexpensive if done overseas ▪ Can be highly customized 	<ul style="list-style-type: none"> ▪ May be difficult to manage ▪ Does not decrease the time for development even if cheaper

13.4.1 Analysis of Mobile Application Development Choices

In general, the mobile application development decisions can be based on the following three factors:

- **User interfaces.** Are new user interfaces needed to support mobile applications or can the existing user interfaces do the job? In most mobile applications, new user interfaces are needed for the handsets that use WAP, i-mode, etc.
- **Databases.** Are new databases needed to support mobile applications or can the existing databases do the job? For example, a new database may be needed to support positional applications or an existing database may need to be “downsized” and loaded onto a handheld device.
- **Business functions.** Are new business functions needed to support mobile applications or can the existing business functions be invoked from mobile devices to satisfy the requirements? For example, many existing applications have code that performs regularly used business functions such as generating bills, checking inventory levels and crediting/debiting accounts. The question is: can this code be reused and installed on a handset or should it reside on the back-end systems and be invoked from the handset?

Table 13-5 shows how these three factors can be used to systematically make appropriate decisions. These decisions are explained below.

Table 13-5: Mobile Application Development Choices

Database Needed	Business Functions Needed	User Interface Needed	Potential Choices
New	New	New	Many choices are available because everything is new: <ul style="list-style-type: none"> • Buy a commercially available new system if it satisfies the needs • Rent from a service provider if available • Develop a new system from scratch • Outsource development
Existing	New	New	Develop new application code and user interface (e.g., Web)
New	Existing	New	Develop a new user interface that invokes existing code
New	New	Existing	Develop new databases and application code
Existing	Existing	New	Develop new user interface (e.g. Web) to access existing (legacy) applications
Existing	New	Existing	Invoke new application functions from existing user interface
New	Existing	Existing	Develop a new database that is accessed from existing application code and user interfaces
Existing	Existing	Existing	Use existing application. May require some re-engineering if the existing application is too old.

Legend:

- Unshaded rows: need entirely new application (application engineering)
- Lightly shaded rows: need a combination of new and existing (application engineering and re-engineering)
- Dark shaded row: need to reuse existing applications only

Note that most real life situations require a combination of engineering/re-engineering.

Purchasing off-the-shelf applications is a viable solution when completely new applications are needed. This strategy, if feasible, is by far the most attractive. Consequently, it must be considered as the first choice. For example, if an m-commerce application is needed and the requirements seem to be satisfied by an off-the-shelf m-commerce system from a vendor, then this package should be evaluated seriously. The key evaluation criteria are:

- Will this package satisfy the current as well as future requirements?
- Will this package scale well from a few mobile users to thousands?
- Will this package interoperate with other systems such as a back-end payment and shipping system?
- What is the experience of the current user base?
- Does it conform to the wireless as well as IT industry standards?

Build Your Own. In many cases, some or all portions of an application (databases, application code, user interfaces) need to be developed in-house. For example, it is possible that the requirements can be satisfied by engineering (designing, developing, and deploying) a new tracking application that needs to reside on a handset. In a few cases, all components of new applications need to be developed for handsets.

Re-engineer/Reuse Existing: Re-engineering (i.e., redesign, migration, interfacing) of existing, in many cases legacy, applications is an important aspect of IT practice at present. For example, it may be possible to satisfy the requirements by re-engineering (i.e., interfacing and migrating) the existing databases completely or partially to a mobile platform. In particular, many handheld devices need to access enterprise data. In several cases, the requirements can only be satisfied by re-engineering and migrating the user interface to handheld devices.

Rent and/or Outsource from a Service Provider: As discussed in Chapter 2, service providers (SPs) in the Internet economy are making it possible for companies to rent and/or outsource many of their services. It is theoretically possible for a newly formed company to parcel out *everything* by using a variety of service providers. In particular, the role of wireless application service providers (ASPs), discussed in Section 13.4.5, is of particular importance in mobile application planning.

Cost and time saving are the two basic drivers for using SPs. For example, a startup company may need a variety of applications such as payroll, inventory, purchasing, order processing, etc. to get started. Buying, installing, and running these applications and the needed IT infrastructure would require an up-front cost even when there are none or very few customers. However, renting these applications from an SP can be much more economical on a per-usage basis. Naturally, you should be careful in outsourcing or renting critical applications. We will consider outsourcing and wireless ASPs later.

13.4.2 In-House Development and Deployment of Mobile Applications

Let us take a closer look at in-house development and deployment of mobile applications. This requires engineering of new and re-engineering of existing, including legacy, applications. Engineering of new applications to support mobility involves the following generic functions:

- Specification and analysis of requirements that are driving mobile application development
- Design of an application architecture which satisfies the functional, interoperability, portability and integration requirements and conforms to the necessary standards
- Development of mobile application system components (programs, user interfaces, databases) based on the middleware and mobility services (e.g., Web Services, .NET, J2EE, WAP, i-mode, GPS software)
- Development, purchase and/or customization of “adapters” that glue the new system components together with existing applications
- Installation and configuration of new application system components
- Centralization/decentralization of implementation activities

The re-engineering of existing applications to add mobility features usually requires “front-end” integration, i.e., access of existing content from a variety of mobile devices. For example, an M-CRM application just adds mobile access to an existing CRM application. This involves:

- Design of a mobile user interface on the mobile device using a micro-browser or a voice-browser, depending on the type of application.
- Determination of how the existing content will be displayed (rendered) on the mobile device. A gateway program may be needed to dynamically convert the content (rendering). An alternative is to use pre-fabricated content that is prepared for mobility ahead of time and then just displayed when needed.
- Special consideration for location services such as positional commerce.
- Choice of the appropriate middleware services needed (e.g., WAP or i-mode).
- Analysis of security threats and development of a security solution to mitigate the threats.

These engineering/re-engineering functions can be performed by a centralized development/deployment group or can be decentralized. The main advantage of centralized development/deployment is maximization of developer time. The following scenarios illustrate the choices (we will consider outsourcing later):

- A completely centralized development/deployment group which performs all analysis, evaluation, implementation and installation for all application system components. This represents a software house which develops/deploys all software in an enterprise. The group can enforce standards and corporate policies. However, the group falls apart quickly if it cannot keep pace with the demands to introduce new and modify existing systems quickly.
- A completely decentralized development/deployment operation where all functions for all application systems at all support levels are conducted by the users. This represents an information center or end-user computing option where the end users select and install their own packages (usually word processing, spread sheets, databases, web-based query processors and packaged applications) on their own computers. This approach gives a great deal of freedom to the end-users but is not conducive to corporate standards and enforceable policies.
- A distributed development/deployment operation, which centralizes few functions for few components at few support levels. The rest of the functions are decentralized. For example, the centralized department may provide consulting and guidance on user interface design, software design and database design, leaving the implementation and installation to the users. This represents a technology transfer center which is responsible for overall direction for application development in the enterprise, and is a good compromise between complete centralization and decentralization. The main management challenge is to decide what to centralize and what not to (so what else is new!).

13.4.3 Acquisition and Installation of Wireless Infrastructure

The wireless infrastructure, as stated previously, includes wireless network hardware and software for cellular, WLANs, WLLs, and any other type of wireless networks (e.g., free Space Optics). In addition, the appropriate middleware and application development environments (e.g., WAP, i-mode, Wireless Java) need to be chosen. Acquisition and installation of hardware and software needed to support mobile applications involves the following generic functions:

- Analyzing user requirements. The users of this infrastructure are the mobile applications at C2B, B2B, and other levels.
- Evaluating and selecting vendor hardware/software which satisfies the user requirements
- Establishing pricing structures (e.g., bulk purchase rates, maintenance prices) with selected vendors
- Establishing procedures for administrative approval before an order is sent to a vendor
- Receiving and verifying ordered components
- Installing, testing, and configuring the ordered components

In a manner similar to the applications development, these functions can be performed by a centralized purchasing/installation center or can be decentralized to end users. The main advantage of centralized acquisition/installation, as mentioned previously, is enforcement of standards and policies. Centralized systems can also direct the users to common software usage across all environments in an enterprise. However, centralized purchasing and installation can be quite slow in large organizations. In such cases, “regional” purchasing and installation may be more appropriate.

A great deal of effort is needed to support the growing number of mobile infrastructure components. The support can be at the consulting level only, where the user receives guidance in selecting the appropriate components to be ordered and then receives instructions on how to install the systems. This may be extended to an administration model where a central purchasing/installation group selects, evaluates, installs, and configures everything.

Naturally, the choice of centralization/decentralization depends on the type of components and the level of support. Consider the following scenarios:

- A completely centralized purchasing/installation center, which performs all functions for all components at all support levels. Due to complete centralization of all decisions and activities, this scenario is only appropriate for small enterprises.
- A completely decentralized purchasing/installation operation, where all functions for all components at all support levels are conducted by the users. This scenario is appropriate for large decentralized enterprises.
- A “distributed” purchasing/installation operation, which centralizes a few functions for a few components at a few support levels. The rest of the functions are decentralized. For example, the centralized purchasing/installation may just provide consulting and guidance on LAN acquisition and installation, leaving the actual ordering and installation to the users. This scenario may be appropriate for many enterprises.

13.4.4 Renting and Outsourcing Through Service Providers

Outsourcing (hiring someone else to do a job on your behalf) or renting (using someone else’s facilities for a fee) have been attractive business practices for several years. A wide range of service providers (SPs) in the Internet economy are making it possible for companies to outsource and/or rent many of the capabilities they need. Simply stated, a service provider offers you a set of services based on an agreed-upon contract. The services can be business

services such as physical site security, or technical services such as software development or Web hosting. It is theoretically possible for a newly formed company to outsource and rent *everything* by using a variety of service providers. That is the essence of a **virtual enterprise** – it relies exclusively on service providers. This is a very attractive choice for mobile services where a variety of specialized service providers can offer needed services ranging from mobile application development to running wireless LANs.

Different service provider models, centered around the Internet, are popular at present. For example, businesses and consumers can rent services from service providers such as the following (see Figure 13-14):

- Network service providers (NSPs) that provide the network “pipe” (end-to-end network communication and routing services). Examples of NSPs for wireless are the cellular phone companies. In addition, several hotspots based on Wi-Fi LANs are being provided as part of the “Free and Open Wi-Fi” movement [Schmidt 2003].
- Internet Service Providers (ISPs) that support Web services and provide access to the public Internet. America Online is a well known example of an ISP. In addition, ISPs are also beginning to provide wireless web services.
- Platform Service Providers (PSPs) that provide the platform services (computing hardware, operating systems, basic middleware) needed to support e-commerce or other applications for buying and selling over the network. PSPs in essence are similar to the old “computing centers” that offered the computing hardware/software for business applications. PSPs that specialize in e-commerce are also referred to as CSPs (commerce service providers). Examples of PSP/CSPs are Rightworks.com, CommerceOne, and Ariba.net. In the mobility domain, examples are the companies that support m-commerce sites, such as EZ-publishing.
- Application Service Providers (ASPs) host application components (mostly business-aware) that clients use over a wide-area network. A very wide range of ASPs have emerged in recent years with services that range from payroll to inventory control. For example, major software vendors such as SAP, Oracle, and Peoplesoft are becoming ASPs. We will discuss mobile ASPs in more detail later.
- Business Service Providers (BSPs) that provide business services such as mail delivery, customer support, and building security.

Cost and time saving are the two basic drivers for outsourcing through SPs. Figure 13-15 shows the basic cost motivation. Let us take the example of a startup software company to illustrate the basic idea. This company needs to use a variety of applications such as payroll, inventory, purchasing, order processing, etc., to get started. Buying, installing, and running these applications and the underlying platforms would require an up-front cost even when there are none or very few customers. Outsourcing, i.e., renting these applications from an SP, can be much more economical on a per-usage basis. However, as the customer base grows, the cost of renting may exceed the cost of owning, as shown in Figure 13-15. In addition to cost savings, time savings can be a big factor in outsourcing – you can use services more quickly from a service provider than by struggling through your own purchase, acquisition, and install cycle. According to the ASP Forum (www.aspforum.com), building your own infrastructure requires a minimum of 8 months to a year for a small company, while it can be done in a matter of weeks by using SPs. For example, ASPs like Corio can support a new customer in 4 to 14 weeks for large applications that may require several months to purchase and set up. According to the ASP forum, customers can also save between 30 to 40% by using an ASP model.

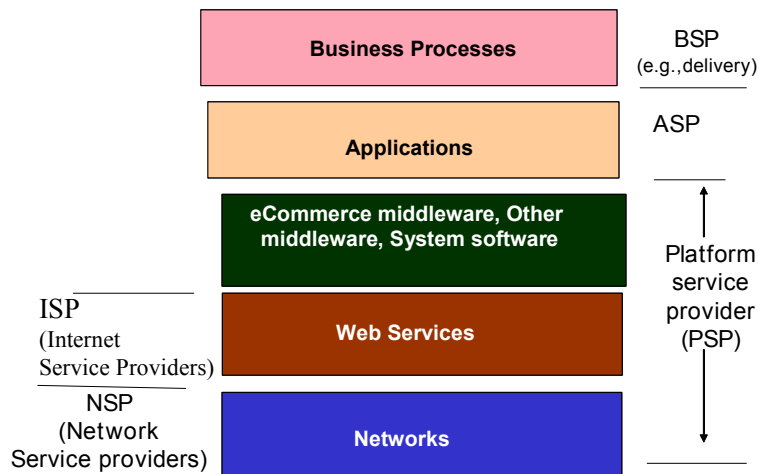

Figure 13-14: Types of Service Providers

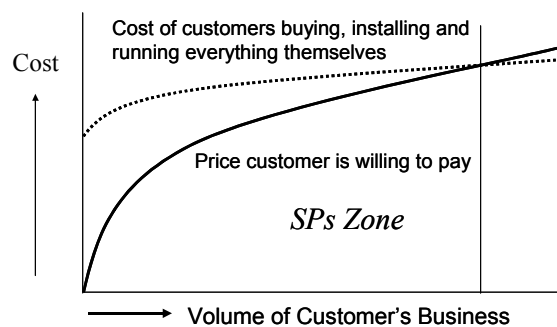

Figure 13-15: Cost Motivation for using Service Providers (SP)

Outsourcing does raise several management issues. For example, once your systems have been outsourced, how do you maintain control over your systems? Your customers still demand quality service whether you support the systems yourself or through a service provider. A successful working relationship with your SP is naturally essential. For example, a joint management of the outsourced assets needs to be negotiated. In addition, service level agreements (SLAs) need to be spelled out clearly as part of the contract and these, plus other, agreements need to be managed on a day-to-day basis. Finally, once a long-range relationship with an SP has been established, then it is a good idea to help the supplier strengthen its operations. For these and other outsourcing management issues, see McNurlin [2001], Chapter 8). More information about different aspects of outsourcing can be found at the site: www.outsourcing-research.com.

13.4.5 Application Renting and Outsourcing Through Wireless ASPs

Many companies are positioning themselves as “Mobile/Wireless ASPs” where a user can access a set of mobile applications without investing in wireless infrastructure and application development. A common mobile ASP architecture is shown in Figure 13-16. With this approach, the vendor provides a platform, hosted or licensed, that receives requests from

mobile devices. Then, acting as a proxy for the mobile client, it uses standard Internet protocols (HTTP, SSL if needed) to retrieve information from the ASP website, often in XML format. The platform delivers the information in a format specific to the device – whether WAP, i-mode or another handheld format. This formatting (rendering) may or may not be dynamic, depending on the ASP. In addition, financial settlements and payments with back-end banks may or may not be assisted by the ASP. Different ASPs also support wireless access to different types of applications (vertical markets, financial trading, and portals). This depends on the type of applications with which the ASPs have some experience (naturally!). Other differentiating factors are how the ASP applications integrate with other related applications, the types of networks and mobile devices the ASPs support, and what level of customer assistance they provide.

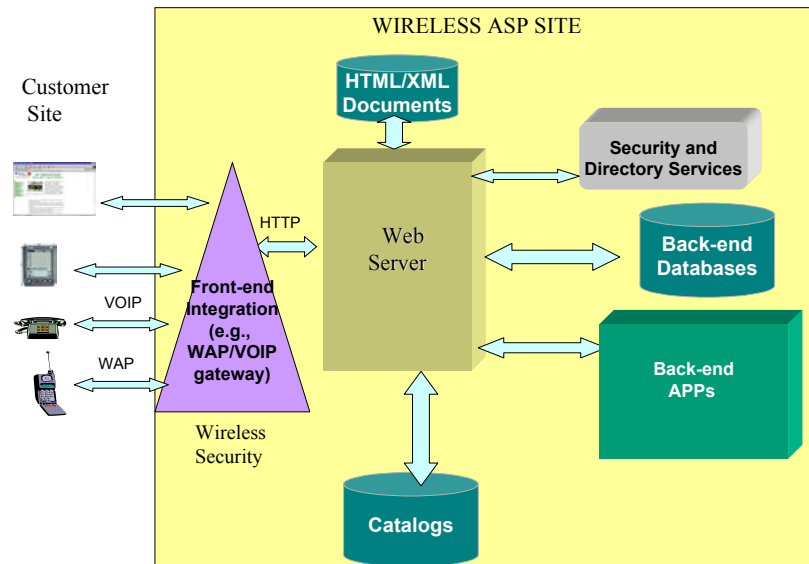

Figure 13-16: Wireless ASPs

Several ASPs are offering mobile/wireless application services at the time of this writing. Examples include OracleMobile, Novarra, 724 Solutions, Broadbeam, and Snaz Commerce, among others. These and other wireless ASPs offer different types of applications over different types of devices with different price structures. Many business challenges exist for these wireless application service providers to become successful. First, the service buyers have to be assured that the wireless application service provider (WASP) understands their business -- they feel uncomfortable, for example, buying services from a wireless carrier who is unfamiliar with their industry and business processes. In addition, the service buyers need to feel assured that the offering provides the required levels of security, performance, reliability, and scalability. The issue of coverage is also important if the buyers have to select a single wireless carrier for wireless access to enterprise applications. Finally, the WASPs have to develop solid partnerships to provide end-to-end service offerings.

Detailed analysis of commercially available wireless ASPs is beyond the scope of this book. See [Evans 2001] for more discussion.



- Time to Take a Break
- ✓ • Strategic Planning
 - ✓ • Capability Evaluation and Development
 - Monitoring and Control

13.5 Monitoring and Control – Wireless Network Management

13.5.1 Overview

Once the wireless systems have been developed and deployed, they need to be monitored and controlled on an ongoing basis. This includes important issues such as fault tolerance and performance measurements of wireless networks, mobile databases, mobile computing platforms, and mobile computing applications. Of particular importance are the wireless management systems that are becoming available, with answers needed to the following questions:

- Are there any failures in the system?
- Are there any performance bottlenecks?
- Is security being properly enforced?
- Are changes in the system being propagated uniformly?

The model of a management system is based on the Open Systems Interconnect (OSI) Management Functional Areas as defined by the International Organization for Standardization (ISO). The particular issues in monitoring and control are defined by ISO in terms of the following services:

- **Fault Management.** Fault management is concerned with detecting, isolating, and correcting faults in the networks as well as the application systems. The basic goal of fault management is to provide smooth and fault-free operations. The required fault management functions depend on the nature of the applications and networks being managed. Since downtime is intolerable in most wireless networks and mobile applications, the fault management must be proactive (i.e., it should forecast faults and provide support to prevent fault occurrence).
- **Performance Management.** The goal of performance management is to maintain system performance to satisfy user response time requirements. The overall response time of the system should be maintained at acceptable levels even if the workload on individual system components (wireless access points, BTSs, wireless gateways, mobile databases, etc.) varies.
- **Security Management.** Security, as defined in the previous chapter, is concerned with defining and enforcing PIA4 (privacy, integrity, authorization, authentication, accountability, and availability) considerations. Security management in a wireless system is responsible for monitoring and controlling the PIA4 considerations for various components at the wireless network, platform, and application levels.
- **Configuration Management.** Configuration management facilitates the normal and continuous operation of mobile applications and the underlying wireless networks. It assures, for example, that a wireless access point is configured properly to handle the

needed users. Configuration management works with other management functions, such as fault and performance management, to correct or optimize the system's performance.

- **Accounting Management.** This involves recording usage of system resources and generating billing information. Capture of accounting information for billing is an important consideration for cellular network providers, as expected.

These services are known as **FCAPS (Fault, Configuration, Accounting, Performance, Security)** and are at the foundation of the “Management Platforms” introduced in the next section. Such platforms, specifically developed for wireless networks, are discussed in the balance of this section. Although our focus is on FCAPs at network levels, FCAPS can be applied at all levels, even at the business-process level (see the sidebar, “Business Performance Management through Wireless – An Example”).

Business Performance Management through Wireless – An Example

Wireless software running on WAP-enabled phones and Personal Digital Assistants (PDAs) allows managers to keep track of business performance when they are traveling. An example of such software is the Gentia Balanced Scorecard that enables businesses to monitor business activities such as customer satisfaction, quality of service, response time and long-term strategic vision. The Wireless Scorecard enables users to receive alerts and reminders pertinent to managing business activities. The user can then access performance-related information from the scorecard application and respond to the application-generated alert. Security is provided through encryption offered by cellular carriers as well as Secure Sockets Layer (SSL) security.

Source: www.gentia.com

13.5.2 Management Platforms – The General Principles

13.5.2.1 What is a Management Platform?

Simply stated, a management platform is a collection of technologies that help enterprises manage their IT assets (networks, computers, databases, applications, middleware, etc.). Ideally, these platforms help in the management of **FCAPS** at all levels (from business processes to the network and computing hardware devices). The first, and by far the most popular, example of management platforms is the network management platforms that were introduced in the late 1980s. At present, the management platforms monitor and control entire “systems” that consist of networks plus the hosts (computers, databases, middleware, system software, and applications). The use of management platforms for wireless systems is relatively new and is still evolving at the time of this writing. This section reviews the basic principles of management platforms. Management platforms for wireless are discussed in the next section.

Figure 13-17 shows a generalized management platform that manages a large number of “subjects” (**managed systems**) in an organization. The managed systems are the IT resources that must be managed by an enterprise for its day-to-day business (e.g., networks, databases, middleware, computers, etc.). The management platform itself consists of many sub-managers (e.g., network services manager, middleware services manager, application managers) that manage individual services of the managed systems. **Agents** In each managed

system keep the managers informed. For example, an agent for Oracle databases could keep track of Oracle database status and inform the managers about the health of these databases. The management agents supply information to a *control panel* for display and also take commands from the control panel to start/stop/reconfigure the managed systems. The terms “distributed systems management” and “management platforms” are often used interchangeably because management platforms are intended to manage all distributed system resources.⁴ Many management platforms in the “wireline world” are commercially available at present. Examples are IBM Tivoli, Computer Associate Unicenter, HP Openview, and BMC Patrol. Some of these platforms are now adding wireless management capabilities.

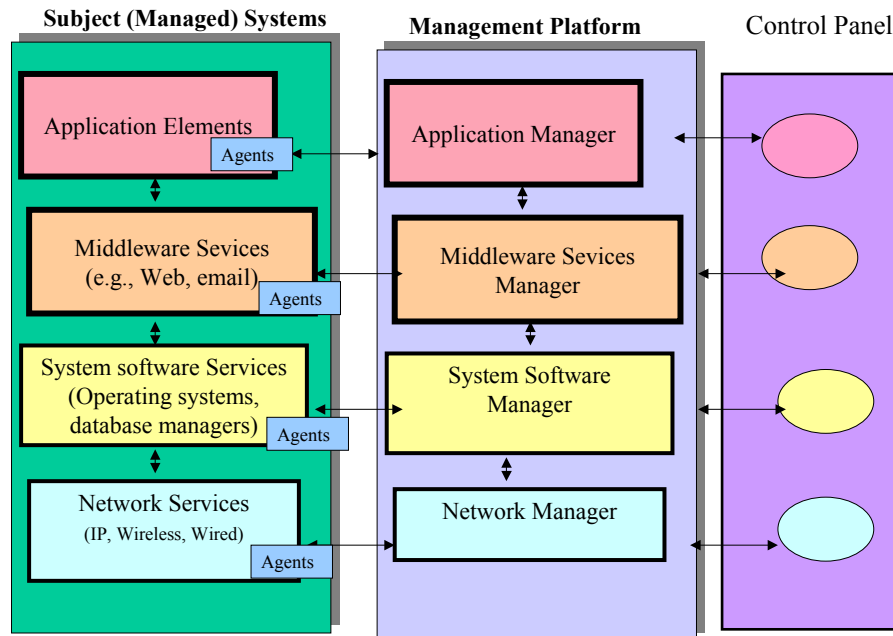

Figure 13-17: Management Platforms – An Idealized View

Although the management platforms exist at several levels, network management has received the most attention due to the complexity and reliance of corporate operations on enterprise networks. The major goals of a network management platform are:

- Improve network availability (up time) and service.
- Centralize control of network components.
- Reduce complexity.
- Reduce operational and maintenance costs.

13.5.2.2 Network Management Platforms at a Glance

The term network management was first used formally by IBM in 1986 when IBM announced NetView. Since then many vendors, corporations and standardizing bodies have been introducing products and defining different aspects of network management. Figure 13-18 shows conceptually how network management can be achieved in large networks. The model can be single level in which a global (enterprise) network manager directly communicates with the network devices. But a more realistic approach, as stated previously, involves multiple levels where the enterprise network manager communicates with different

⁴ The term “system” is used in IT to typically represent all IT resources such as applications, databases, the computers that house them, and the networks that interconnect them. These resources are, naturally, distributed at various sites.

domain managers and each domain manager supervises its own network (typically a LAN). The model is based on a manager-agent model – the manager-agent dialog uses network management protocols that define:

- The format of the management information and the rules for information exchange between manager and network agents
- Transportation of information between the managers and the agents
- The specific information exchanged (e.g., network device status)

The first two problems are typical in any protocol standard development. The third problem, although not necessarily unique, is quite complicated in network management. The collection of management information that a manager or an agent knows is called **Management Information Base (MIB)**. A manager must know the MIB of its agents.

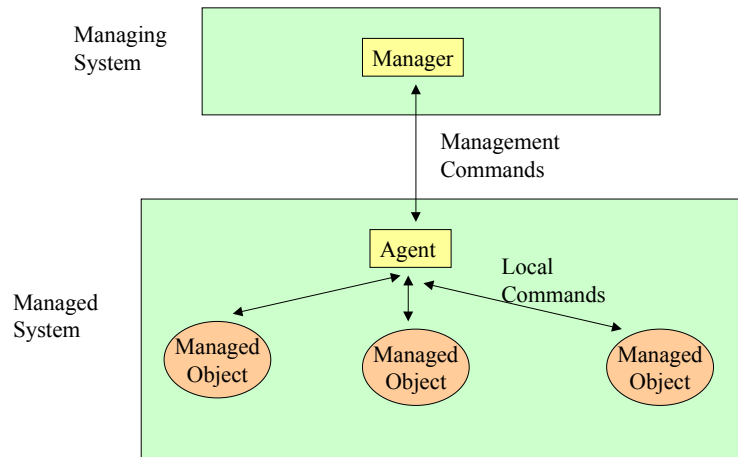

Figure 13-18: Network Management Communications

Since the 1970s, some of the network management functions have been emphasized more than others, and the tools have evolved from manual and standalone tools to sophisticated knowledge-based integrated systems. The methods and tools in network management have evolved through several stages. At present, the focus of network management is on (distributed) systems management where all system resources are monitored and controlled through management platforms. The emphasis is on enterprise management systems that coordinate various other network managers for managing large heterogeneous environments. As shown in Figure 13-19, the individual network management systems (called domain or element managers) manage portions of the network (e.g., a wireless network) and pass information to the enterprise manager. The next generation of management tools are appearing as expert support systems (ESS) and decision support systems (DSS) to support the network planning, installation, maintenance and performance activities. These systems are exploiting the advances in AI, database technologies and software engineering for large and complex network management and enterprise management systems. Ideally, these systems would have a common user interface which invokes tools that access configuration information for problem solving.

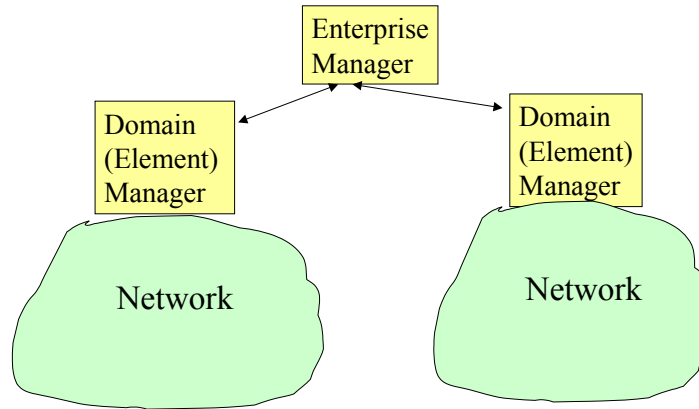

Figure 13-19: Enterprise Network Management View

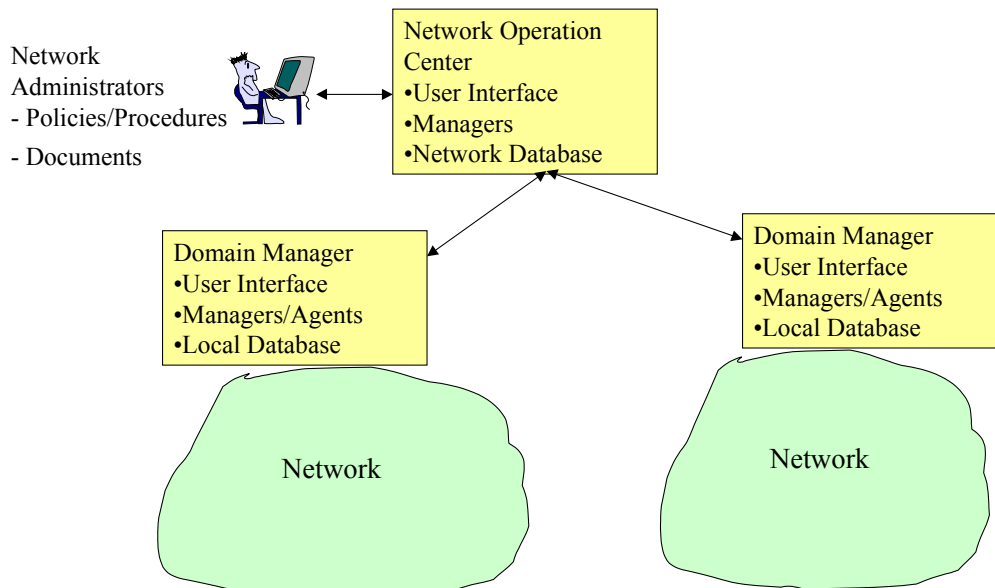

Figure 13-20: A Network Operations Center

Figure 13-20 shows a Network Operations Center (NOC) where the network experts monitor, diagnose and control the network. An integrated toolset is needed for the NOC personnel for timely decision making. In addition, policies and procedures are needed about how the NOC will handle normal as well as emergency situations. The functions of network planning, administration and security can be also assigned to NOC personnel because they know a great deal about the networks.

13.5.2.3 TCP/IP Network Management: Simple Network Management Protocol (SNMP)

Management of TCP/IP networks has moved to the center stage due to the dramatic popularity of the Internet. As we all know, TCP/IP is the foundation of the Internet. In fact, the Internet is a collection of TCP/IP networks. Thus a large number of TCP/IP networks exist within an enterprise. For example, an intranet is a collection of enterprise LANs that use TCP/IP. Corporate intranets and extranets use TCP/IP over ATM, Frame Relay, Ethernet, FDDI, and other network technologies. In addition, many dial-up networks use PPP (point-to-

point protocol) that runs under TCP/IP. From a wireless networks point of view, TCP/IP is playing a central role due to the popularity of Wi-Fi LANs and GPRS cellular networks. Needless to say, management of TCP/IP networks is getting most of the attention in enterprise network management and is important for wireless network management.

The need to focus on TCP/IP network management was felt in the late 1980s when TCP/IP started becoming ubiquitous. The Internet Activities Board (IAB) met in early 1988 to determine a strategy about how to manage the growing TCP/IP networks.⁵ The meeting recommended two parallel standards: **the Simple Network Management Protocol (SNMP)** as a short-range solution and the **Common Management Information Services and Protocol Over TCP/IP (CMOT)** as the eventual long-term solution. The TCP/IP community has primarily focused on specifying SNMP mainly because CMOT is essentially the same as the ISO standard CMIS (Common Management Information Services), but it runs on TCP/IP networks. This section mainly discusses SNMP because of its widespread use in wired as well as wireless networks.

Figure 13-21 shows the SNMP architecture. As expected, SNMP views a network in terms of managers which manage the network and agents which represent the resources being managed. The SNMP managers are designed primarily to provide the following two facilities from remote sites in large TCP/IP networks:

- Fault management
- Configuration management

Note that many other network management functions (e.g., security management) are not explicitly included in SNMP. However, SNMP protocols can define many types of data, thus they can be used to collect and view data outside the realm of SNMP “standard” functions. For example, some performance monitoring is possible with SNMP by storing and viewing performance data at appropriate intervals. SNMP uses the less-reliable UDP instead of the reliable TCP services. The network management applications using SNMP are provided with a set of simple primitives (Get, Set, Get-Next) which are specified in the ISO **Abstract Syntax Notation One (ASN.1)** language. In addition, a Trap message allows six types of events to be reported asynchronously. SNMP specifies a core of 100 objects, termed “**MIB-1,**” which comprise a management information base (MIB). MIB-1 only specifies fault management and configuration management objects. **MIB-II** has also become available and contains an additional 185 objects. SNMP specifications consist of the SNMP protocol over a UDP/IP stack, MIB-1 and MIB-II, and the rules for the Structure of Management Information. The SNMP managers and agents can use the following commands and packet types for network management:

- GetRequest – used by the manager station to query agents on the status of objects
- GetNextRequest – A GetRequest that sequentially steps through the MIB
- SetRequest – manager directs a change in the value of a MIB object
- GetResponse – agent answers a GetRequest
- Trap – agent notifies the manager that a significant event has occurred.

⁵ This section uses some of the TCP/IP terms. The uninitiated reader may review the IP Networks Chapter in the Networks Module before proceeding.

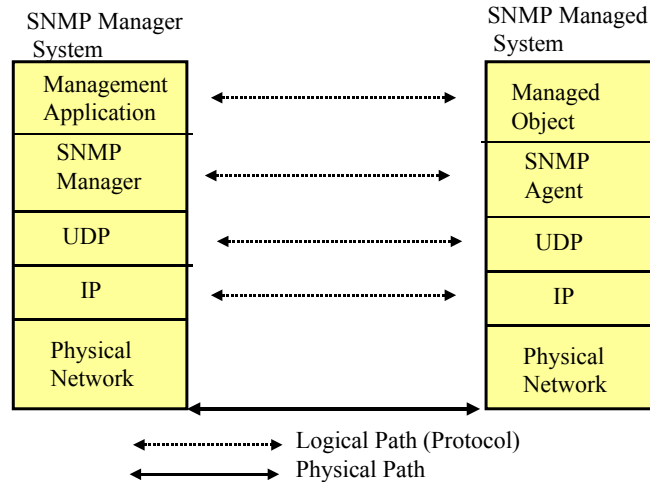

Figure 13-21: TCP/IP Network Management (SNMP)

The Simple Network Management Protocol (SNMP) is essentially a request-reply asymmetric protocol, operating between a management station (smart) and an agent (dumb). Since the agent is the device being managed, all its software has to do is implement a few simple packet types and a generic get-or-set function on its MIB variables. The management station presents the user interface. Simple management stations can be built with simple command-line utilities. More complex ones collect MIB data over time and use GUIs to draw network maps.

Figure 13-22 shows a simple example of an SNMP conversation. If needed, statement 1 unlocks a resource (e.g., a device) for issuing queries (resources can be “locked” by administrators). After this, statement 2 shows a request by the manager to receive the status of the unlocked device. Statement 3 displays the response from the agent about the device status. The main features of SNMP are as follows:

- SNMP uses the UDP connectionless protocol. This means that there is no overhead involved in establishing the connections. The applications may need to employ some type of protocol to assure that messages sent from one side are received properly on the other side.
- SNMP applications are limited in several ways: The amount of information retrieved in one request is limited (cannot link several replies for one request), the MIB browsing is slow and tedious, no direct imperative commands (e.g., shut down a system) are supported, and SNMP traps are always unconfirmed. These limitations do not exist in CMIP/CMOT.
- SNMP devices are named via IP addresses and SNMP objects are represented using a subset of ASN.1.
- SNMP uses polling to communicate with the devices being managed. Thus the SNMP manager polls each device to retrieve diagnostics information. The polling method works well for small networks (about a hundred devices) but is very inefficient for large networks because a great deal of time is spent in polling. In contrast, event-based management is employed in some systems (e.g., CMOT) which respond to certain conditions. Event-based systems are harder to implement but are more efficient for large and complex networks.

A great deal of information is available on TCP/IP network management. See, for example, the sidebar, “TCP/IP Network Management Selected Sources for Additional Information.” For an extensive discussion of management platforms, see Chapter 3 of Umar [2004].

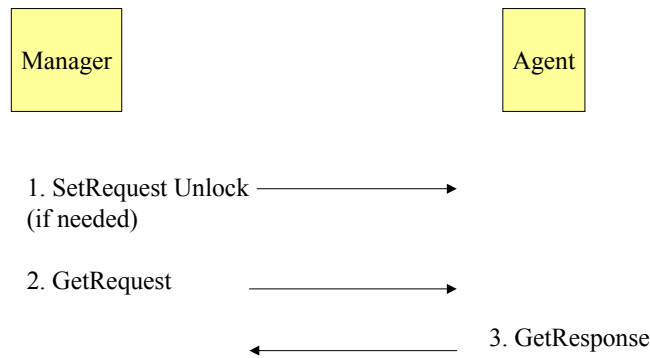

Figure 13-22: SNMP Example

TCP/IP Network Management Selected Sources for Additional Information

- Mauro, D. and Schmidt, K. *Essential SNMP*. O'Reilly, July 2001
- Hamedy, S. *Total SNMP: Exploring the Simple Network Management Protocol*. 2nd ed. Prentice Hall, 1997.
- The NET-SNMP Project (<http://net-snmp.sourceforge.net/>)
- SNMP Research International, Inc. (www.snmp.com/)
- www.simpleweb.org – website with numerous links and information on network management, including software, RFCs and tutorials
- www.SNMPLink.org – a good reference site on SNMP and Network Management.
- www.rad.com/networks/1995/snmp/snmp.htm – tutorial on SNMP

13.5.3 Principles of Wireless Network Management

13.5.3.1 Overview

The wireless networks need to be managed for FCAPS (fault, configuration, accounting, performance, security). Although they share standard elements and mechanisms, wired and wireless networks have significant differences. In addition to the conventional wired network, wireless network management needs to address the following unique issues:

- **Roaming.** The main characteristic of wireless networks is to support dynamic cell connection or roaming – the process of changing the network connection of a mobile device from one access point to another. This is a unique situation within the wireless environment that is nonexistent in wired networks.
- **Persistence of Mobile Units.** Handheld devices are turned on and off frequently throughout the day, making it difficult to monitor these devices. This is unlike desktop systems or other wired network components that operate continuously or are powered off only occasionally and can be monitored easily.
- **Lack of SNMP Agents in Mobile Units.** For handheld devices, memory space and processor speed are highly limited resources, making it difficult to provide SNMP agents for these devices. In contrast, desktop or laptop computers have adequate amounts of memory and processor power to support an SNMP agent operating as a background task handling requests from the Network Management station. Thus the ability of devices

utilizing wired and wireless networks to “host” an SNMP agent is another differentiating factor that impacts network management functionality.

- **Mobile Adhoc Networks.** The mobile adhoc networks (MANETs), as discussed in a previous chapter, create totally different situations that are unique to wireless networks. For example, MANETs can associate with different systems just by being in the vicinity. In addition, MANETs are peer-to-peer networks in which new devices can be quickly added or deleted on an as-needed basis. This creates special challenges that do not exist in wireline networks.

These unique features must be addressed at the fault, performance, security, configuration, and accounting levels, as discussed in the following sections.

13.5.3.2 Wireless Fault Management for Reliability

Wireless fault management is intended to increase the reliability and quality of wireless services through early detection, isolation, and correction of abnormal wireless network operation. Fault management for wireless networks provides the means to receive and present fault indication, determine the cause of a network fault, isolate the fault, and perform a corrective action on the access points, base stations, MTSOs, and other wireless infrastructure components.

Wireless networks, especially cellular ones, are not exactly known for quality. Several factors (security, convenience, increased efficiency) influence the decision of choosing mobile devices. However, reliability and quality is a key factor, especially given that a large percentage of users want to depend on their wireless phones in times of emergency. Wireless carriers need to offer the same reliable connections that users expect from their wireline phones. Some high-profile cases have raised public awareness about the limitations of wireless 911. A southern California woman, for example, filed a lawsuit against L.A. Cellular (Los Angeles) when her wireless 911 call went unanswered because she was in a “dead zone” of the coverage area. Besides cellular, there are issues with fixed wireless services. Carriers offering or planning to offer services through such systems suffer from wireless’ poor reputation for quality. In addition, fixed wireless networks suffer from losses due to rain, storms, and a wide range of intervening objects such as trees and buildings.

With wired connections such as DSL, cable, leased lines, and frame relay there is the chance of a router, CSU/DSU, or repeater failure. There can also be failures due to the phone company, or a construction crew, cutting phone lines in your area. Wireless networks generally do not suffer from these failures. However, weather conditions such as rain, snow, fog, sun spots, smoke, etc., can interfere and sometime disrupt a wireless network – in particular, a cellular, satellite, or wireless local loop.

Wireless fault management software allows for fault management of the wireless infrastructure (the MTSO equipment and software, the BTSs, the access points, and other wireless network devices). For example, RiverSoft’s (www.riversoft.com) Fault Manager supports Cisco’s wireless system such as Cisco’s gateway GPRS support node (GGSN), packet data serving node (PDSN) and Catalyst switches. The fault management software provides a correlation capability for isolation and determination of root causes of network problems. Some of the features of wireless fault management are:

- Extensive diagnostic tools to analyze potential problem areas.
- Event notification to provide real-time updates on important network events.
- Drill-down or component zooming to expand information about the suspected elements as required.
- Wireless proxy agents to support non-SNMP mobile devices and to keep track of mobile units that do not themselves have SNMP agents.

13.5.3.3 Wireless Performance Management

Performance management tools are used to recognize current or impending performance issues that can cause problems for wireless network users. Activities include the monitoring and maintenance of acceptable network performance, and collection and analysis of statistics critical to network performance.

Many performance management tools for wireless networks provide performance management of multi-vendor and mixed (wired, wireless) networks. In addition, fault management functions are also bundled with performance management. Key attributes of such platforms include:

- Real-time and historical trend analysis of network performance
- Traffic (performance) monitoring with graphical representation of network performance data
- GUI based (usually) performance reporting
- Multi-technology (IP, ATM, Frame Relay, Wireless) performance and fault management
- Multi-technology performance management
- Alarm diagnosis

In addition to wireless network performance, tools for managing performance of wireless applications are commercially available. Performance management support for Web applications based on the Wireless Application Protocol (WAP), as well as i-mode – the wireless protocol developed by NTT DoCoMo – are commercially available. For example, Mercury Interactive has a set of software modules for WAP and i-mode application performance management.

13.5.3.4 Wireless Security Management

Wireless security, as discussed in a previous chapter, is a major area of concern for the users as well as operators of wireless networks. Security management encompasses the activities of controlling and monitoring the access to the wireless network and to associated network management information. This includes controlling passwords and user authorization, and collecting and analyzing security or access logs. The goal of a network management system is to provide this functionality in a concise manner that views the entire network as one homogeneous entity.

Wireless security management provides the tools for defining, monitoring, and controlling secure wireless networks. This involves introduction of encryption to enforce privacy, definition of Access Control Lists (ACLs) to control devices that can attach the network, and assigning IDs/passwords for authentication. We will not dwell on this topic here because we have discussed security issues extensively in a previous chapter.

13.5.3.5 Wireless Configuration Management

Configuration management activities include the configuration, maintenance, and updating of network components. Configuration management also includes notification to network users of pending and performed configuration changes. Due to the roaming issues, wireless configuration management is much more challenging than the wired version. Examples of the functions performed are:

- Access point configuration definitions to maintain configuration consistency
- Network mapping to define associations between mobile units and access points
- Auto discovery for MANETs so that new devices are automatically recognized without any additional re-configuration
- Firmware and software revision control to allow remote management of mobile system components from a central location

13.5.3.6 Wireless Accounting Management

Accounting management provides the ability to track network usage to detect inefficient network use, abuse of network privileges or suspicious usage patterns. Billing is one of the main drivers for capturing detailed accounting information, especially in cellular networks. In addition to billing, accounting management is a key component for planning network growth. For example, accounting reports are needed to track and to discover trends in wireless network traffic and usage statistics. Ideally, this should provide a proactive analysis of network balance issues (i.e., identify heavily versus lightly used components). Auto-discovery, also used in configuration management, is of value because new devices are automatically recognized and tracked for network growth purposes.

13.5.3.7 Future Considerations in Wireless Management

Due to the expanding use of wireless networks, the functionality provided by wireless network management systems (WNMS) must also evolve with time. Current and future WNMS should incorporate support for the following:

- **Conformance to Emerging Standards.** Several wireless standards are evolving, as discussed in previous chapters. It is important for WNMS to conform to these standards because with their acceptance, network management standards, such as SNMP MIBs and RMON (Remote Monitoring) agents, are also being developed to support them.
- **Integration with Network Management Platforms.** Because wireless networks are part of larger wired networks, WNMS should provide an easy integration path into a variety of enterprise network management platforms such as CA Unicenter, IBM Tivoli and NetView, and HP Openview.
- **Moving into Wireless Application Management.** Management of wireless network components is one piece of the overall enterprise puzzle. The management of the wireless applications such as the ones based on i-mode and WAP is the next logical step. Wireless application management provides FCAPS functionality to the wireless applications that are performing mission-critical business operations.

13.5.4 Wireless Network Management Special Cases

Wireless network management needs to be discussed in terms of wireless LANs, cellular networks, and wireless local loops. Table 13-6 summarizes the typical characteristics of the wireless networks and the various management issues. The following sections elaborate on the entries in this table.

Table 13-6: Wireless Network Management Issues

	Wireless Local Area Networks (WLANs)	Wireless Metropolitan Area Networks (WMANs)	Wireless Wide Area Networks (WWANs)
Main Characteristics	Wireless LANs Bluetooth (1 Mbps, 10 meters) IEEE 802.11 LANs (2-11 Mbps, 100 meters)	Wireless MANs wireless local loops (10 Mbps, 100 Kilometers)	Wireless WANs Current GSM systems at 9.6 Kbps, future 3G systems at 2 Mbps
Fault Management	Faults on access points and wireless LAN cards	Faults on WLL transmitters	Faults on BTS and MTS
Performance Management	Performance of access points	Performance of WLL transmitters (distance reached, interference)	Performance of BTS and MTSC, determine cell sizes
Security Management	WEP	Security of WLL	Cellular security (GSM, 3G)
Configuration	Building WLAN	Building WLL	Building cellular

Management	configurations, allocating frequency ranges	configurations, allocating frequency ranges	configurations, establishing HLR and VLR, allocating frequency ranges to cells
Accounting Management	Capturing wireless usage	Capturing usage of wireless services (e.g., wireless cable)	Capturing cellular phone usage and billing

13.5.4.1 Wireless LAN Management

Figure 13-23 shows a simple wireless LAN configuration that needs to be managed. Each station in the wireless LAN has a wireless LAN adapter (in fact a radio transmitter/receiver) that operates in certain frequency ranges. Connectivity to wired networks is provided through an “*access point*,” also known as a local bridge. Wireless LANs use cells, called microcells, similar to the cellular telephone system to extend the range of wireless connectivity. At any point in time, a mobile PC equipped with a wireless LAN adapter is associated with a single access point and its microcell, or area of coverage. Individual microcells overlap to allow continuous communication within a wired network. They handle low-power signals and “hand off” users as they roam through a given geographic area. Figure 13-23 illustrates microcells in a wireless LAN environment.

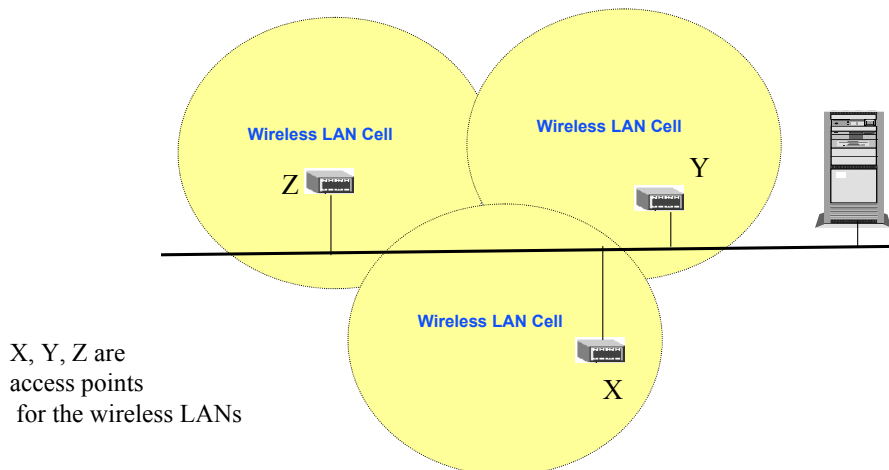

Figure 13-23: A Simple Wireless LAN Environment

The following network management capabilities for WLANs are needed:

- **Fault management:** Faults on access points and wireless LAN cards must be detected, diagnosed and corrected. These problems are complicated due to the multiplicity of devices and protocols such as wireless Ethernet and Bluetooth.
- **Performance management:** The performance of interconnected WLANs which operate at different data rates, connected through access points, cause serious performance bottlenecks due to congestion and collisions. In particular, performance of access points must be managed carefully.
- **Security management:** The broadcast nature of wireless transmission creates a vulnerable situation. Several protocols such as WEP (Wired Equivalent Protocol) have been introduced. However, there are several unsolved security problems with WEP and WLAN security, as discussed previously in Chapter 4.
- **Configuration management:** This involves building WLAN configurations and allocating frequency ranges. This is important for configuration management as well as security purposes.

- Accounting management: The billing for resources used for WLANs has not been considered seriously because LAN billing is not usage-based, typically. In some cases, capturing wireless usage is a good idea for performance reasons.

At present, many existing LAN network management products have added wireless LAN management capabilities. This is mainly done by treating the access point as another LAN bridge. However, some WLAN management products are commercially available. An example is the SpectrumSoft Wireless Network Management System from Symbol Corp. (www.symbol.com).

13.5.4.2 Cellular Wireless Network Management

Figure 13-24 shows a high-level view of a cellular communication network used in wide areas. The cellular network is comprised of many “*cells*,” that typically cover 1 to 25 miles in area. The users communicate within a cell through wireless communications. A **Base Transceiver Station (BTS)** communicates with the mobile units in each cell using wireless communications. One BTS is assigned to each cell. Regular cable communication channels can be used to connect the BTSs to **the Mobile Telephone Switching Center (MTSC)**. The MTSC is the heart of cellular networks – it determines the destination of the call received from a BTS and routes it to a proper destination either by sending it to another BTS or to a regular telephone network. Keep in mind that the communication is wireless within a cell only. The bulk of cell-to-cell communication is carried through regular telephone lines. The MTSC uses two databases called **Home Location Register (HLR)** and **Visitor location Register (VLR)** to locate the mobile users.

Most cellular network management issues generally do not fall under enterprise network management because cellular networks are managed by cellular carriers. The following cellular network management capabilities are reviewed for general interest:

- Fault management: The faults on the BTS and MTSC need to be detected and corrected. These problems are complicated due to the multiplicity of cellular network protocols such as 1G, 2G, 2.5G, and 3G networks (see Bates [2001] and Stallings [2002]).
- Performance management: The performance of BTS and MTSC is an important issue because some BTSs become very busy at peak times (for example, many cellular users call home around 5 PM to indicate that they are coming home). Determining cell sizes for optimum performance is an area of great activity [Stallings 2001].
- Security management: The broadcast nature of cellular transmission creates a vulnerable situation for cellular networks. Cellular security has been improving steadily (from 1G to 3G).
- Configuration management: Building cellular configurations and establishing HLR and VLR databases is an important issue in cellular networks. In addition, allocating frequency ranges to cells is part of configuration management.
- Accounting management: Capturing cellular phone usage for billing is obviously important for cellular network providers.

The main providers of cellular network management products at present are the wireless network providers such as Nokia and Ericsson. Sun Microsystems has funded a wireless network management project called **OSS-J (Operation Support System through Java)** that had initial focus on 3G cellular network management. The current goal of OSS/J is component-based software development applied to managing converged networks that include wireless as well as wired networks. To make OSS-J a success, Sun is partnering with several industrial collaborators such as Ericsson, Motorola, NEC, Nokia, Nortel Networks, BEA, and Borland. The main thrust at present is to define Java APIs for network management that use the Java 2

Enterprise Edition (J2EE) and XML as the integration/middleware framework. Additional information about OSS-J can be found at the website: <http://java.sun.com/products/oss/>.

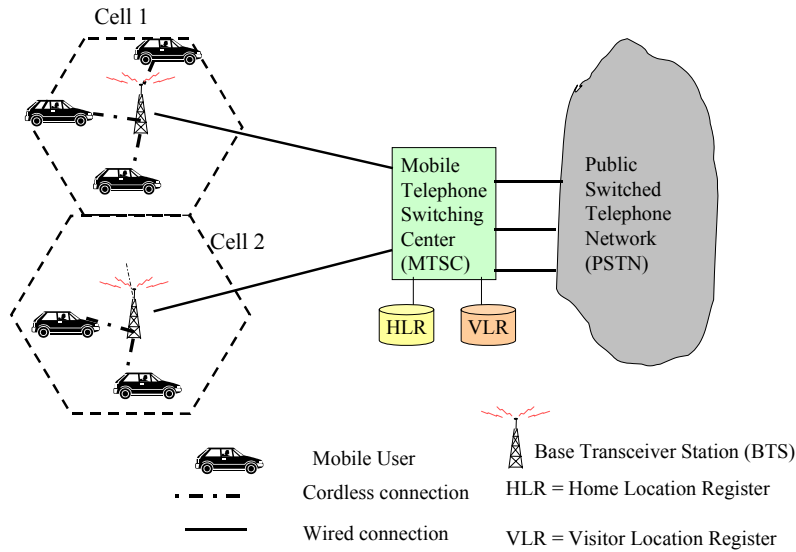

Figure 13-24: A Cellular Communication Network

13.5.4.3 Wireless Local Loop Management

Wireless metropolitan area networks (WMANs) comprise the wireless local loop (WLL) that is gaining popularity with long distance telephone companies. WLLs allow long distance carriers to bypass the existing wired local loops owned by local phone carriers. Figure 13-25 shows a sample configuration in which a local wired loop has been replaced with a wireless local loop. WLLs are quick and cost-effective for quick setup of local phone services. Imagine laying millions of miles of copper cables to set up a local wired loop. Several technologies exist for WLLs. Examples are wireless ATM and LMDS (Local Multipoint Distribution Systems). WLLs are examples of wireless metropolitan area networks and offer around 10 Mbps service.

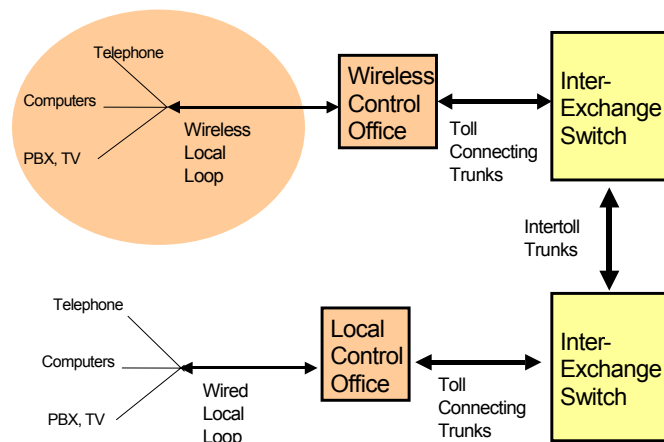

Figure 13-25: Wireless Local Loop

To analyze WLL network management issues, a WLL can be viewed as a large LAN, and thus many of the FCAPS issues discussed for WLANs also apply. In particular, faults on

WLL transmitters need to be managed and performance of WLL transmitters, in terms of distance reached and interference, need to be studied.

13.5.5 Brief Examples of Wireless Network Management Systems

Many wireless network management systems are commercially available at present. Here is a look at a few.

13.5.5.1 Wireless Operation Support System (OSS) from Lucent Technologies

Telecom Operation Support Systems (OSS's) support the planning, provisioning, and operation of telecom systems. Wireless carriers are turning to wireless OSS's to deal with improving capacity and quality while reducing costs. This has highlighted the importance of wireless OSS software that is currently estimated at more than \$750 million.

Lucent Technologies has developed a wireless OSS, called WatchMark, that enables the customers to monitor and control wireless networks. WatchMark is developed by a special company formed by Lucent and provides software tools to enable customers to maintain their wireless networks through the Web over their private networks. WatchMark uses flexible, reusable object-oriented platforms to allow wireless carriers to design networks that allow more callers to get onto the network with fewer dropped or blocked calls.

WatchMark's product line consists of many components to support different aspects of wireless management. These include the WatchMark Pilot™ network decision support tool, the WatchMark Design™ Radio Frequency (RF) design and optimization tool, the WatchMark Control™ multi-vendor network mediation tool, and the WatchMark Extreme™ Web-based decision support system.

13.5.5.2 Cisco Wireless Network Management Suite

Cisco Wireless Network Management Suite (CWNMS) is a client/server-based network management application suite for broadband fixed wireless deployments. This platform allows users to auto-discover network elements, monitor alarms, configure network elements, monitor RF channel performance, perform loop back tests, and track network inventory. CWNMS consists of:

- **Cisco Wireless Manager (CWM)** – an SNMP-based network management application that provides features for configuring, monitoring, and troubleshooting broadband fixed wireless network components. It also allows customers to monitor and graph network performance statistics in real time, and provides extensive alarm management capabilities.
- **CiscoView Wireless** – an SNMP-based device management application that provides dynamic status, statistics, and configuration information for a wide range of Cisco network elements.
- **Cisco Broadband Troubleshooter(CBT)** – a graphical tool that analyzes and debugs troubled CPEs (customer premise equipment). It provides facilities to classify the CPE errors into provisioning or link errors.

Collectively, CWNMS supports FCAPS for a very wide range of Cisco devices.

13.6 Administrative and Organizational Issues

The activities presented so far raise several administrative and organizational issues that range from mobile virtual teams to mobility in real-time enterprises. This section reviews the basic issues and approaches by using the following questions:

- What type of organizational structure will support the wireless projects?
- Can mobile virtual teams help?
- Can the next generation of real-time enterprises be managed through mobile computing?

13.6.1 Organizational Design in M-Business

To illustrate the main concepts, let us review the structure designs for m-business environments. Such organizations depend heavily on mobility and information technologies for integration of enterprise processes such as procurement, supply chains, customer relationship management, manufacturing, engineering, administration, and office processes. The goal is to produce high quality products/services with minimum cost and in minimum time. m-Business enterprises encounter two sets of organizational problems: a) the typical organizational problems between the product versus functional management, and the engineering/manufacturing/marketing interfaces, and b) the information technology and mobility-related organizational problems of coping with the expectations/implications of new technology. Here is a list of specific challenges in organizational structure design for such systems:

- Organizational units must be able to develop, at Internet speed, new systems for global markets that can be easily integrated with back-end systems. Many of these systems must be developed to operate at Internet scale (i.e., thousands of users), with Internet connectivity (e.g., unpredictable open Internet), and for multiple customers with multiple interests.
- These systems must satisfy multiple, often conflicting requirements for performance, reliability, flexibility and maintainability. For example, EB systems must be based on flexible architectures for evolving customer needs as well as technologies. In addition, these systems must be easily modifiable to reflect changes in competitive market conditions and national/international standards.
- These systems are dispersed among the enterprise units which may be located in different cities or countries. In addition, these systems may change location due to mobility. Consequently, management of integration requires a great deal of interdisciplinary work among geographically distributed units with potentially different equipment, standards, and policies.
- These systems are developed by professionals (systems engineers, computer scientists, business programmers, etc.) with diverse backgrounds, training, specialized terminology, and professional outlooks.
- Development of these items requires an understanding and synthesis/application of existing and evolving tools, techniques, standards and models in enterprise services (e.g., manufacturing), computing devices, communication technologies, systems engineering, and management. These tools and techniques include growing areas, such as database systems, software engineering, artificial intelligence, operations research, distributed intelligence, organizational behavior, and ergonomics.

Figure 13-26 shows a procedure for evaluating various organizational structures which combine many of the existing techniques into a single framework. Our experience has shown that such a systematic approach for a detailed examination and analysis of proposed

organizational structures is quite useful. It has been especially useful in providing a uniform basis for evaluation: it has led to valuable insights and discussions. It was also found that the model was instrumental in keeping the discussions more focused on appreciation of tradeoffs.

1. Identify the problems that need to be addressed (interdependencies, lack of coordination, etc.)
2. Identify the main candidate structures which appear to address the problems identified (should not exceed 4, current structure must be a candidate)
3. List the major requirements to be satisfied by the organization:
 - organizational requirements
 - responsiveness to change
 - integration requirements
 - human needs/requirements
4. Assign importance to the requirements (0 to 5) and choose, if possible, the most important requirements (about 10)
5. Evaluate the candidate structures against the requirements on the scale 0 to 5
6. Repeat steps 1 through 4 if needed
7. Analyze the results and make recommendations

Figure 13-26: A Procedure for Organizational Structure Design

13.6.2 Location-Independent Mobile “Virtual” Teams – IT For Organization Design

Information technologies can help in the organization structure design by developing a location-independent organizational structure. *In such a structure, the IT platform is the organizational structure.* The platform is the corporate intranet (Internet implemented inside an organization) that allows managers and workers to communicate with each other independent of their geographical location. With this structure, the organizational information and decision flows can change (an organization restructure) without moving people’s desks. Thus the organization structure is defined through software, i.e., the desktops and security/authorization/reporting procedures can be reconfigured to define a new organizational structure [Keen 1991].

Let us extend the discussion to mobile “virtual teams” and mobile “virtual enterprises.” Basically, a *Virtual Enterprise (VE)* is a network or loose coalition of a variety of value adding services in a supply chain, that unite for a specific period of time for a specific business objective, and disband when the goal is achieved. An example of a VE is the Virtual Parts Supply Base (VPSB, <http://www.vpsb.com/>) which supplies hard-to-find parts for the US Government. Many organizations are participating in this effort for a specific purpose. Similarly, a virtual team is formed for a specific period of time for a specific business objective, and disbanded when the goal is achieved. For example, Ford Motor Corporation has adopted a cross-continent virtual team model to design its automobiles. Ford launched the Mustang design as a simultaneous collaborative effort between designers in Dunton (England), Dearborn (Michigan), Japan, and Australia [Laudon 2002]. Similarly, the very popular Apache Web Server was developed by a team of independent developers around the

globe. In these cases, the notion of distance in organizational design disappears – the Internet becomes the vehicle for organizational design.

The Internet technologies have eliminated distance as a factor for many types of work for many situations. In addition, wireless systems have eliminated the need for location restrictions. Many employees can work from their homes, cars or boats (these people are crazy!). The workers can collaborate across continents by using the Internet as the communication mechanism. Availability of mobile devices allows the workers and businesses to operate from virtually any location with a satellite or cellular connection. In these cases, the main thing that keeps an organizational structure together is the expertise and the desire of people to work on common projects. The organizational structure itself becomes a mobile virtual concept.

13.6.3 Organizational Design in Real-Time Enterprises

Real-time enterprises are complex sensing organizations that run everything from payroll departments to remote factories across the globe through real-time monitoring [Jones 2002, Lindorff 2002]. To support the monitoring and split-second reaction times across widely distributed business units, the companies have to rely on sophisticated IT infrastructure. Companies such as the Inditex Group are using this model to make sure that every process in the company is instantly accessible to the management layers. The foundation of such organizations is a digital nervous system that connects everything involved in the company's business. This system can be used to monitor everything in real-time from sales operations to supply chains. The main underlying technology for real-time enterprises is the message-oriented middleware that supports a publish-and-subscribe model so that different important events can be posted and responded to by publishers and subscribers, respectively.

What is the role of mobile devices in real-time enterprises? Mobile devices are an important part of the real-time nervous system because they provide real-time access to corporate data from any location anytime. For example, a manager can view the supply chain and customer activity through a cellular phone while sitting in a boring meeting or relaxing on a beach (let us hope not, but you never know). To meet this demand, companies offer solutions that concentrate on how to manage performance of business by using wireless devices. For example, Gentia provides software running on WAP-enabled phones and Personal Digital Assistants (PDAs) to allow managers to keep track of business performance when they are traveling. Gentia Balanced Scorecard enables businesses to monitor the business activities such as customer satisfaction, quality of service, response time and long-term strategic vision by using handheld devices. The Scorecard enables application users to instantaneously receive alerts and reminders pertinent to managing business strategy. The user can then access performance-related information from the scorecard application and respond to the application-generated alerts. Security is provided through over-the-air encryption offered by cellular carriers as well as Secure Sockets Layer encryption and authentication.

What are the implications of organizational design in real-time enterprises? At present, nobody knows for sure. The main ideas are that the organizational design has to be very efficient and flexible to respond to real-time decisions. The notion of virtual teams is very appealing in this context because different groups in different parts of an organization can be interconnected electronically to form new groups to respond to special situations. In addition, each group has to support "agents" that gather information about the various activities and report to the "management command center." The agents could reside on mobile as well as fixed-location devices. This is an interesting area of research.

13.7 Chapter Summary

This chapter has discussed how to manage and support wireless systems as valuable business assets. Figure 13-27 shows the reference model that has been used throughout this book to identify the major building blocks of mobile systems (applications, databases, middleware, networks) that need to be planned, organized, monitored, and controlled. As shown in this model, all building blocks need to be managed. We have customized, for wireless, the well-known management cycle of strategic planning, capability evaluation, organizing/staffing, development/deployment and monitoring/control.

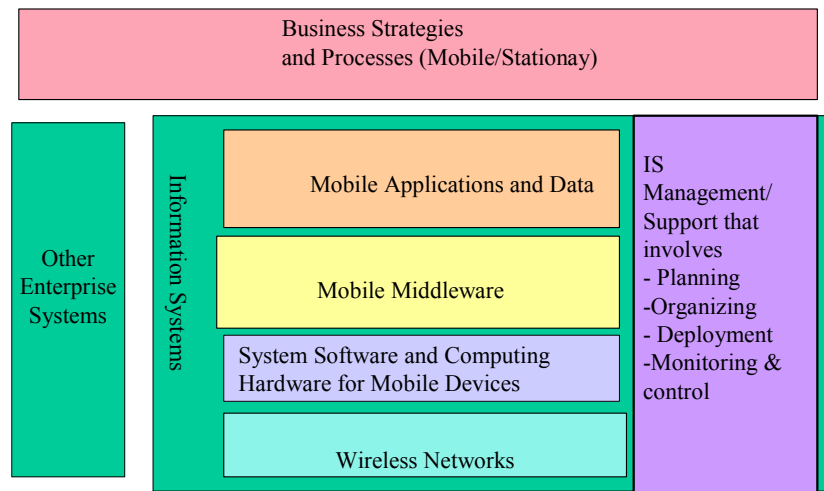

Figure 13-27: Distributed Systems Reference Model

13.8 Review Questions and Exercises

- 1) Develop a table to show the main management processes and the tools available for each process for wireless.
- 2) What is the main objective of business strategic analysis and why is it relevant to wireless systems?
- 3) Why should business processes and workflows be analyzed for wireless? Explain through an example.
- 4) What is the basis for considering mobile applications? Explain through an example.
- 5) What are the unique issues in capacity planning and traffic engineering for wireless?
- 6) Describe the acquisition and deployment policies of a company that you are familiar with (preferably in the wireless domain).
- 7) Expand Table 13-4 to capture additional plusses and minuses. Can this table be converted into a flowchart that can help a company to decide between the choices?
- 8) Describe the major issues in monitoring and control of wireless systems.

- 9) Suppose you have been asked by your company to design a wireless management platform for corporate WLANs. List the main features you would include in this product.
- 10) Conduct a literature survey to find some commercially available wireless management platforms.
- 11) List the wireless management issues, in order of priority, that have not been addressed adequately in the current literature.

13.9 References

- Adams, J., et al. *Patterns for e-Business: A Strategy for Reuse*. IBM Press, October 2001.
- Applegate, L., et al. "Information Technology and Tomorrow's Manager," *Harvard Business Review* (Nov.-Dec. 1988), pp.128-136.
- Betz, J. *Executive Strategy*. John Wiley, 2001.
- Boar, B. *The Art of Strategic Planning for Information Technology*. 2nd ed. Wiley, 2001.
- Charan, R. "How Networks Reshape Organizations – For Results," *Harvard Business Review* (Sept.-Oct. 1991), pp. 104-115.
- Clemens, E. "Evaluation of Strategic Investments in Information Technology." *Communications of the ACM* (Jan. 1992), pp.22-37.
- Cronin, M. *The Internet Strategy Handbook*. Harvard Business School Press, 1996.
- Davenport, T. "Putting the Enterprise into Enterprise Systems." *Harvard Business Review* (July/August 1998).
- Davenport, T. H. and Short, J. E. "The New Industrial Engineering: Information Technology and Business Process Redesign." *Sloan Management Review* (Summer 1990), pp. 11-27.
- Davydov, M. *Corporate Portals and eBusiness Integration*. McGraw-Hill Professional Publishing, 2001.
- Drucker, P. "The Coming of the New Organization," *Harvard Business Review* (Jan.-Feb. 1988).
- Evans, M. *Business Agility: Strategies For Gaining Competitive Advantage Through Mobile Business Solutions*. Prentice Hall, 2001
- George, J. and King, J. "Examining the Computing and Centralization Debate." *Communications of the ACM* (July 1991), pp. 63-72.
- Geier, J. *Wireless LANs*. 2nd ed. SAMs Books, 2002.
- Gurbaxani, V. and Whang, S. "The Impact of Information Systems on Organizations and Markets." *Comm. of ACM* (Jan. 1992), pp.59-73.
- Hammer, M. *The Agenda: What Every Business Must Do to Dominate the Decade*. Crown Pub., 2001.
- Hammer, M. and Champy, J. *Reengineering the Corporation: A Manifesto for Business Revolution*. Harper Collins Publishers, 1993.

- Hammer, M. "Reengineering Works: Don't Automate, Obliterate." *Harvard Business Review* 68, No. 4 (1990), pp. 104-112.
- Highsmith, J. "Structured Systems Planning." *Information Systems Management* 4, No. 2 (Spring 1987).
- Jones, J. "Moving into Real Time." *Infoworld* (January 17, 2002).
- Kalakota, R. and Robinson, M. *e-Business 2.0 – Roadmap for Success*. Addison Wesley, 2000.
- Kalakota, R. and Robinson, M. *M-Business: The Race to Mobility*. McGraw Hill, 2002.
- Keen, P. *Shaping the Future: Business Design Through Information Technology*. Harvard Business School Press, 1991.
- Kleinrock, L. *Queuing Systems – Vol. 2*. John Wiley, 1976.
- Laudon, K. and Laudon, J. *Management Information Systems*. 7th ed. Prentice-Hall, 2002.
- Laudon, K. and Laudon, J. *Management Information Systems*. 8th ed. Prentice-Hall, 2003.
- Lee, J., Siau, K., and Hong, S. "Enterprise Integration with ERP and EAI." *Communications of the ACM* (Feb 2003).
- Lim, W. "Cost-Benefit Analysis of Component-Software." *eAI Magazine* (April 16, 2003).
- Lindorff, D. "GE's Drive to Real-Time Measurement." *CIO Magazine* (November 11, 2002).
- Luftman, J. *Competing in the Information Age: Strategic Alignment in Practice*. Oxford University Press, 1996.
- McNurlin, B. and Sprague, R. *Information Systems Management in Practice*. 5th ed. Prentice Hall, 2001.
- Menasce, D. and Almeida, V. *Scaling for E-Business: Technologies, Models, Performance, and Capacity Planning*. Prentice Hall, 2000
- Nystrom, P. and Starbuck, W. *Handbook of Organizational Design*. Oxford University Press, 1981.
- Porter, M. "Strategy and the Internet." *Harvard Business Review* (March 2001).
- Rockart, J. "The Changing Role of the Information Systems Executive: A Critical Success Factors Perspective." *Sloan Management Review* 24, No. 1 (1982), pp. 3-13.
- Rockart, John, "Distributed Data Processing Model." *SHARE 48* (March 4-11, 1977).
- Sawhney, M., et al. *The Seven Steps to Nirvana: Strategic Insights into e-Business Transformation*. McGraw-Hill Professional Publishing, 2001.
- Schmidt, T. and Kormann, D. "Why Wi-Fi Wants To Be Free." *Communications of ACM* (May 2003).
- Severance, D., and Passino, J. *Making I/T Work*. Jossey-Bass, 2002.
- Stallings, W. *Wireless Communications and Networks*. Prentice Hall, 2002.
- Turban, E. *eCommerce 2002: A Managerial Perspective*. Prentice Hall, 2002.
- Umar, A. *e-Business and Distributed Systems Handbook: Management Module*. 2nd ed. NGE Solutions, August 2004.

- Umar, A., Krackenburg, R. and Lyons, T. "Organizing for Computer Integrated Manufacturing." *Information and Management Journal* 20 (1991), pp. 355-362.
- Ward, J., and Griffiths, P. *Strategic Planning for Information Systems*. Wiley Information Systems Series, 1996.
- Whyte, W., and Whyte, B. *Enabling e-Business – Integrating Technologies, Architectures & Applications*. John Wiley & Sons, 2001.
- York, T. "Perfect Fit." *CIO Magazine* (Jan.-Feb., 2001).
- Yu-Lee, R. *Essentials of Capacity Management*. John Wiley, 2002.