

A

한글

[자음 익히기]

ㄱ, ㄴ 익히기 ①

◆ ‘ㄱ’ 이 되도록 선을 그어 보세요.

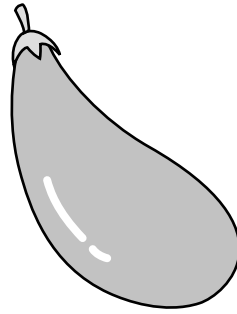
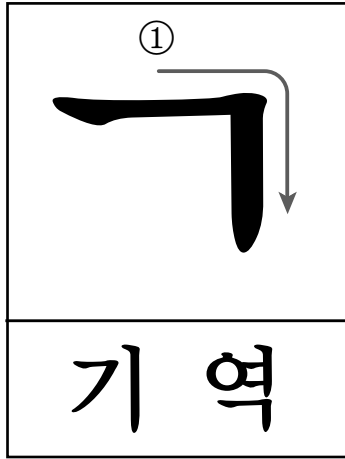

가지

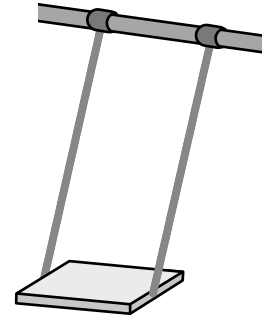



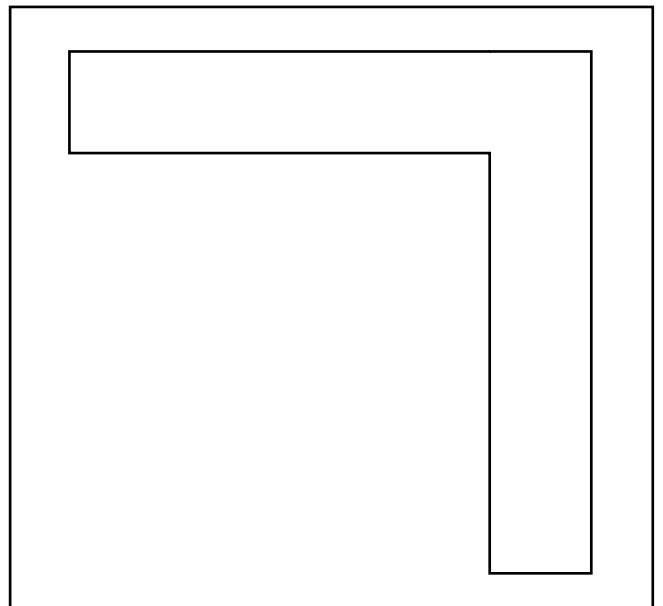
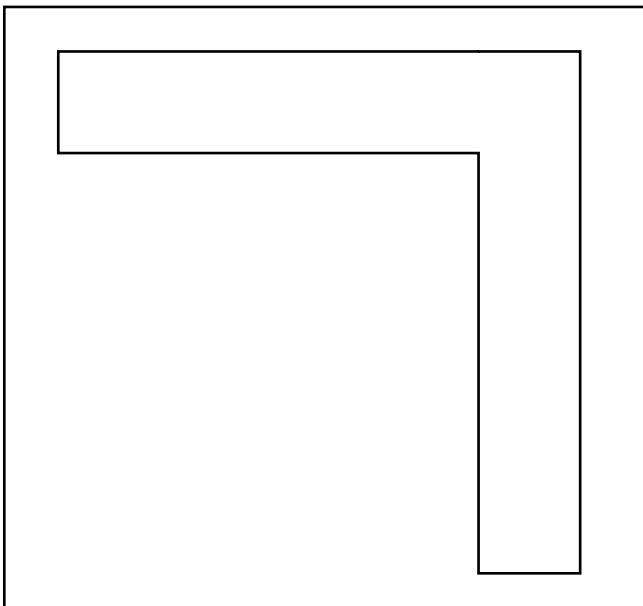
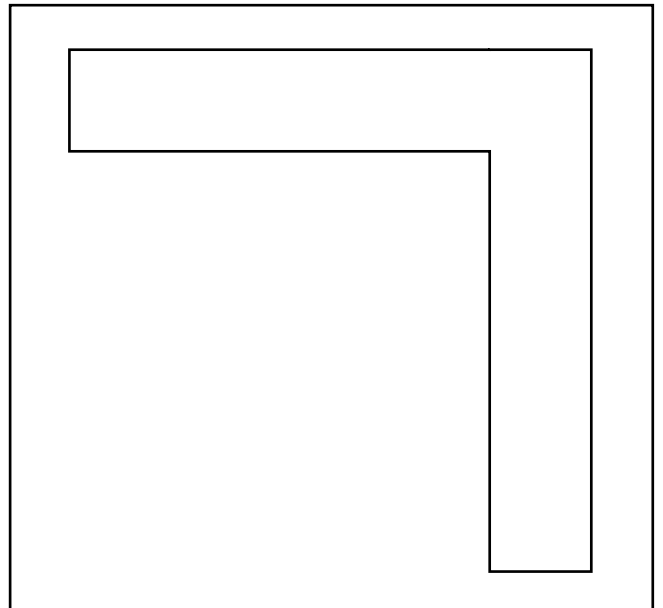
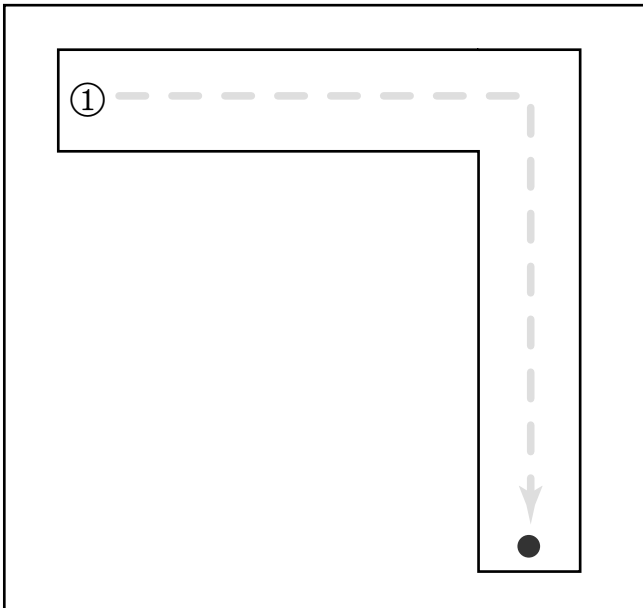



그네

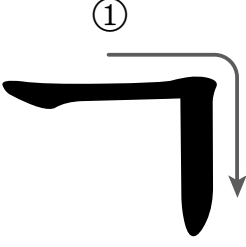
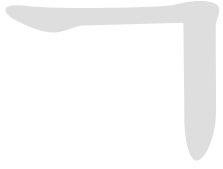

A**한글** [자음 익히기]

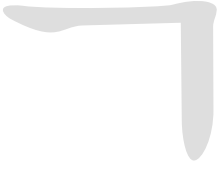
ㄱ, ㅋ 익히기 ②

◆ ‘ㄱ’ 을 큰 소리로 읽으면서 써 보세요.

A

한글

[자음 익히기]

ㄱ, ㄴ 익히기 ③

◆ ‘ㄴ’ 이 되도록 선을 그어 보세요.

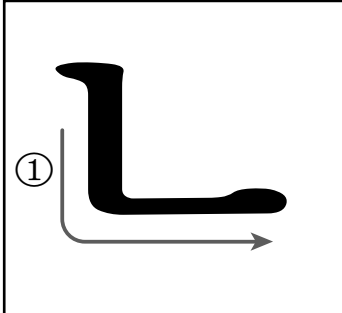

ㄴ 은

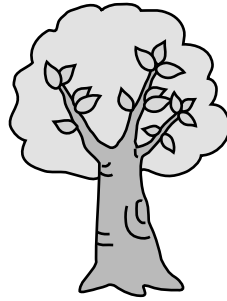

나무

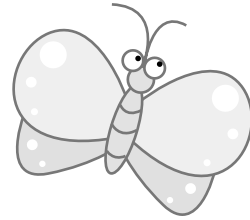



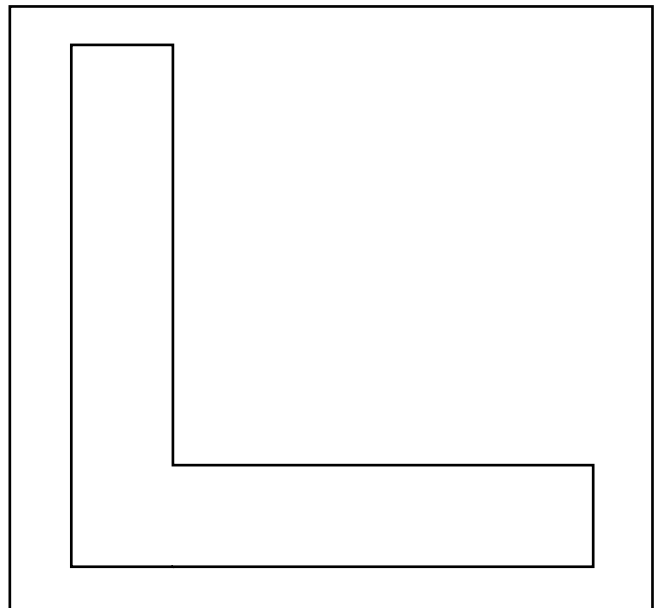
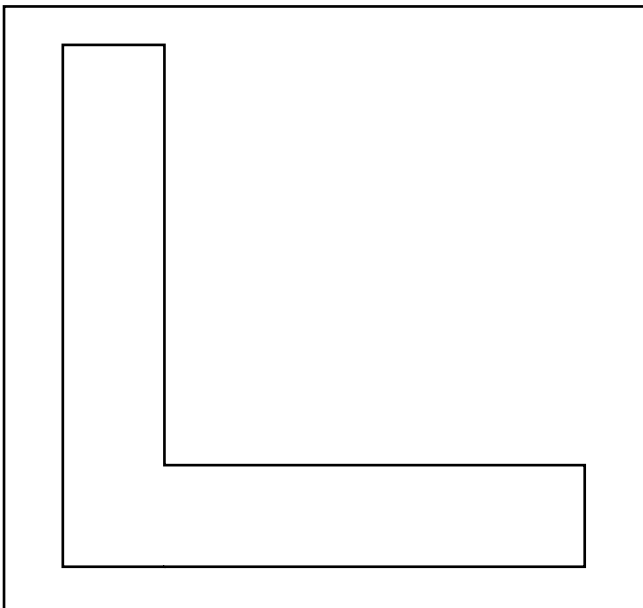
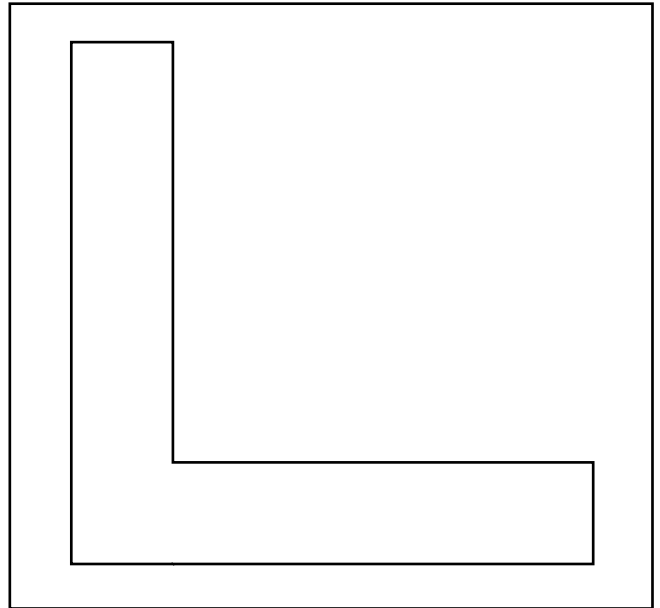
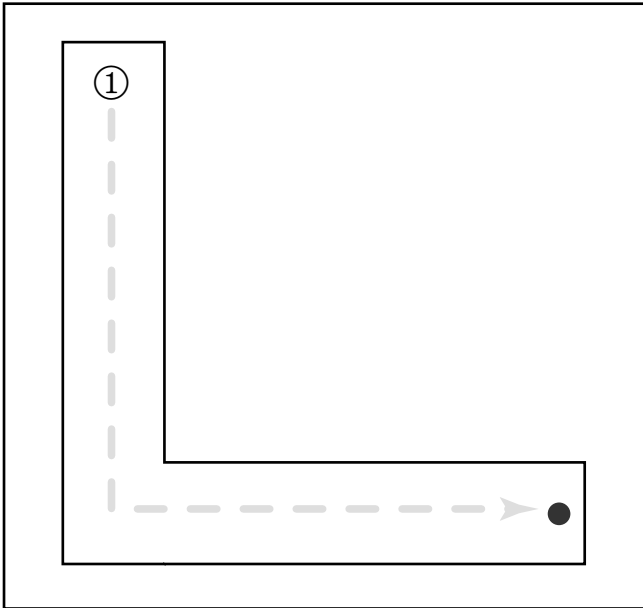





나비

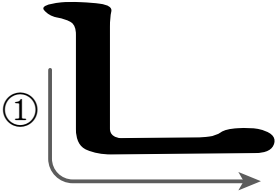

A**한글** [자음 익히기]

ㄱ, ㄴ 익히기 ④

 'ㄴ' 을 큰 소리로 읽으면서 써 보세요.

A**한글****[자음 익히기]****ㄱ, ㄴ 익히기 ⑤**

◆ 첫글자에 ‘ㄱ’ 이 들어간 낱말을 찾아 ○를 그려 보세요.

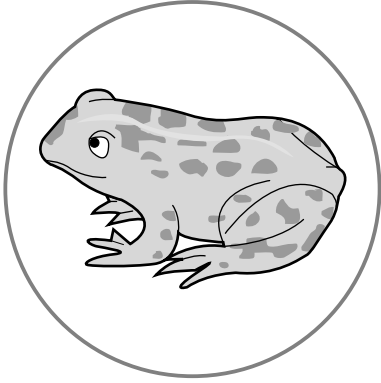

개구리



코알라



나팔

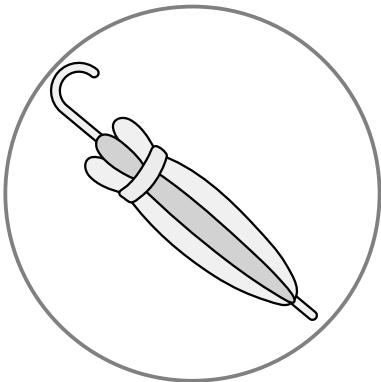

우산

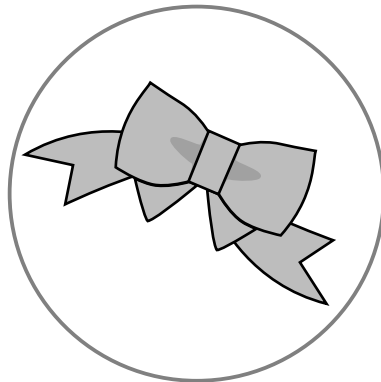

리본



구두



사자

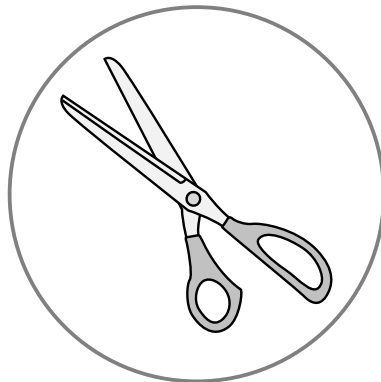

가위

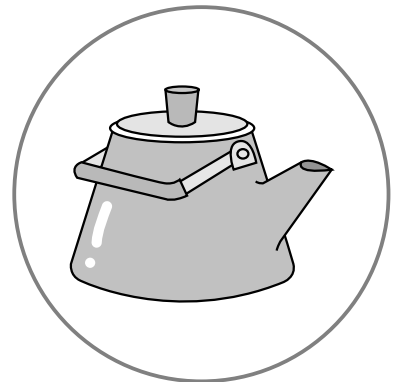

주전자

A**한글**

[자음 익히기]

ㄱ, ㄴ 익히기 ⑥

첫글자에 ‘ㄴ’ 이 들어간 낱말을 찾아 ○를 그려 보세요.

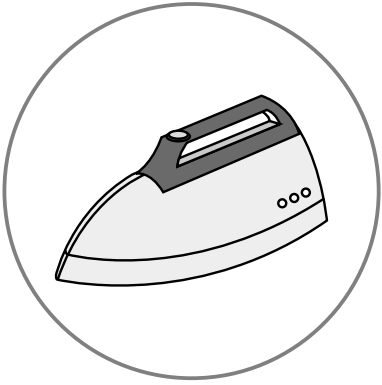

다리미

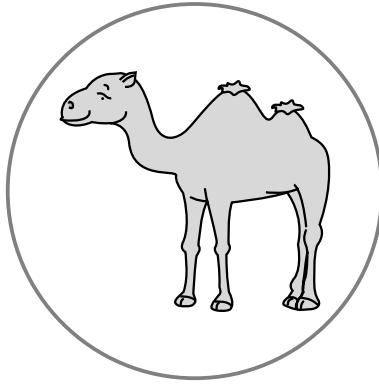

낙타

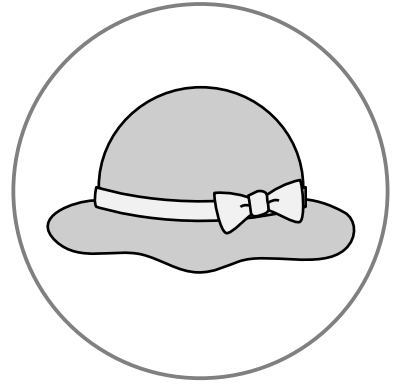

모자

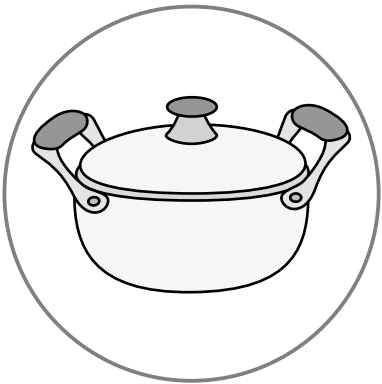

냄비

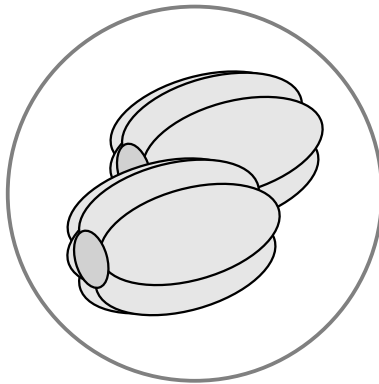

참외



가방



너구리



사탕

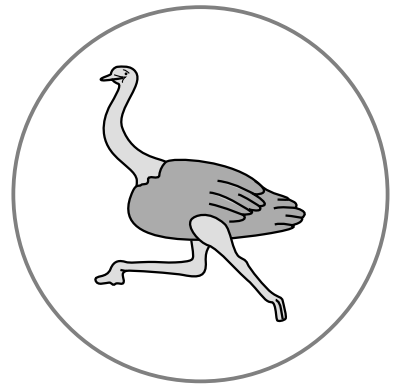

타조

A

한글

[자음 익히기]

ㄷ, ㄹ 익히기 ①

◆ 'ㄷ' 이 되도록 선을 그어 보세요.

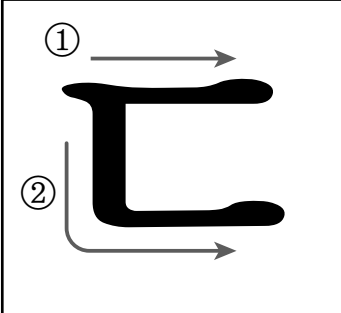

ㄷ 큰

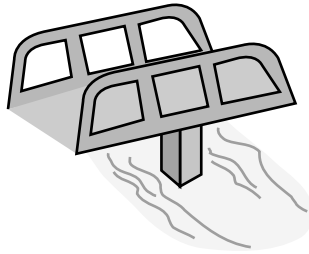

다리

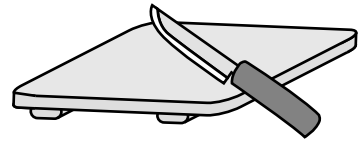



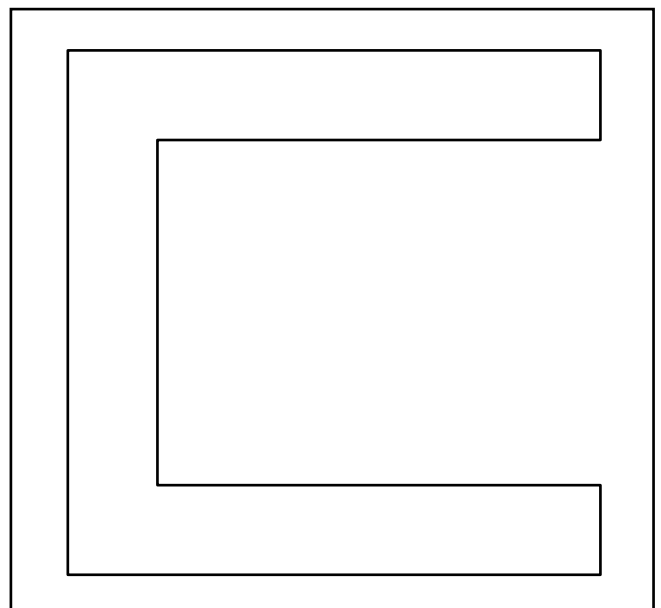
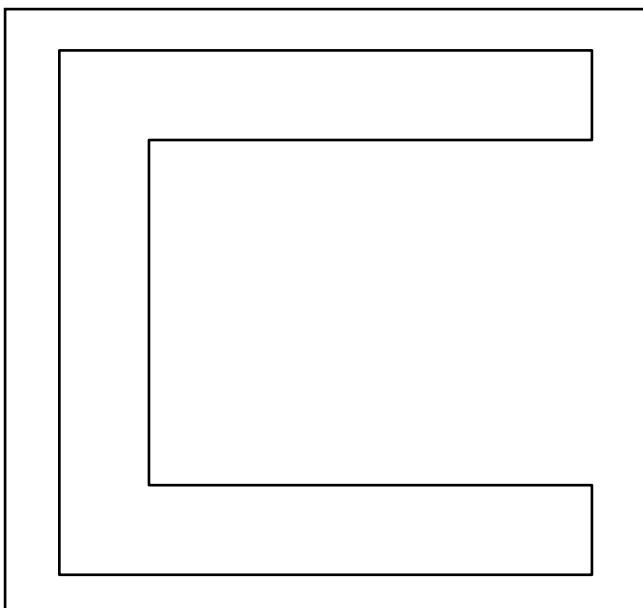
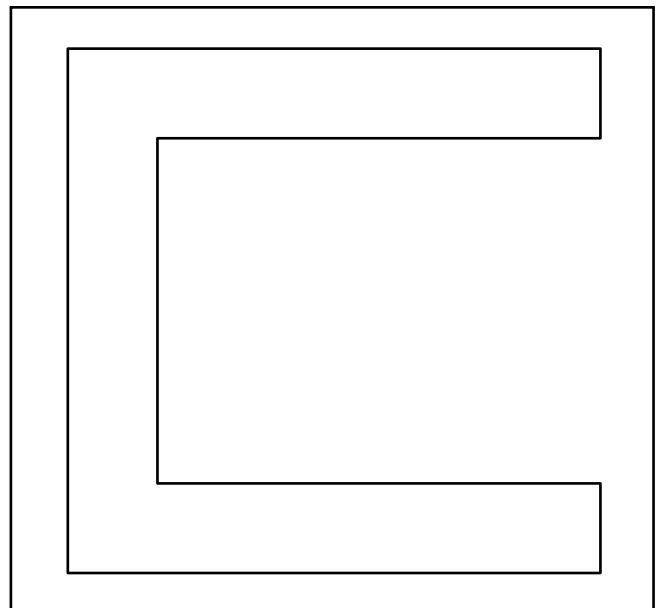
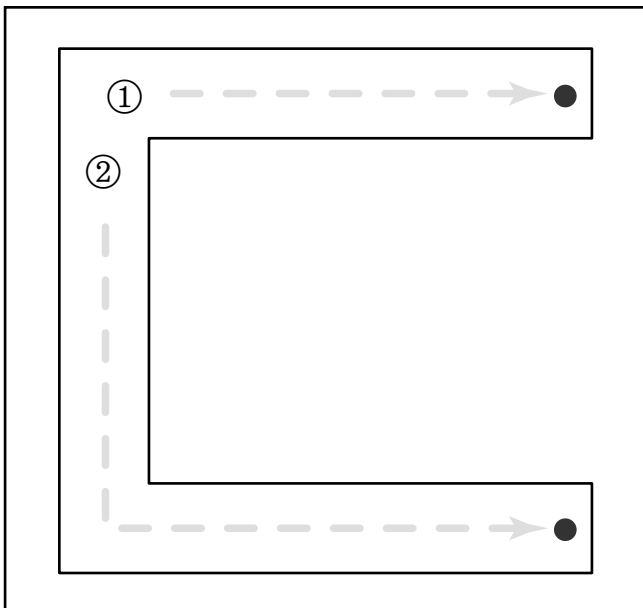



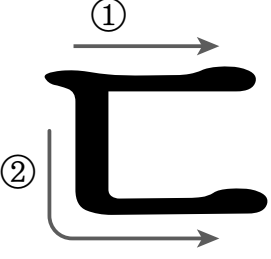

도마



A**한글****[자음 익히기]****ㄷ, ㄹ 익히기 ②**

 'ㄷ' 을 큰 소리로 읽으면서 써 보세요.

A

한글

[자음 익히기]

ㄷ, ㄹ 익히기 ③

◆ 'ㄹ' 이 되도록 선을 그어 보세요.

리 을

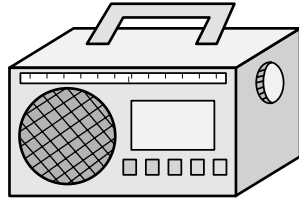

라디오

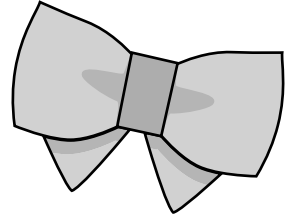

리본

A**한글****[자음 익히기]****ㄷ, ㄹ 익히기 ④**

📖 ‘ㄹ’ 을 큰 소리로 읽으면서 써 보세요.

	ㄹ	ㄹ	ㄹ
ㄹ	ㄹ	ㄹ	ㄹ

A

한글

[자음 익히기]

ㄷ, ㄹ 익히기 ⑤

◆ 'ㄷ' 이 들어간 구름만 예쁘게 색칠해 보세요.

거울

도토리

다람쥐

개미

치마

두부

당근

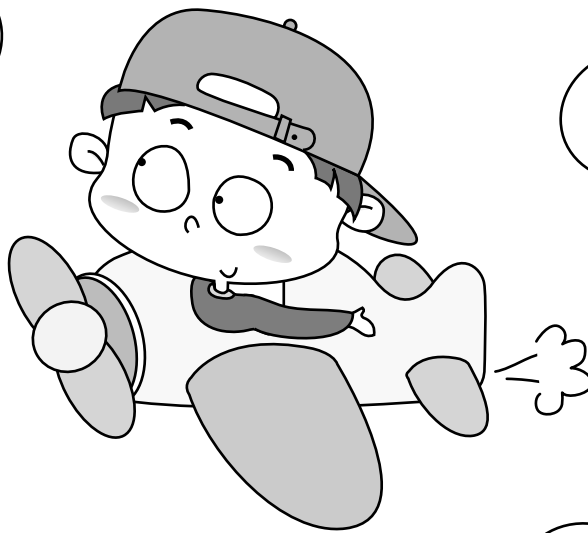

포도

우유

A**한글** [자음 익히기]

ㄷ, ㄹ 익히기 ⑥

◆ ‘ㄹ’ 이 들어간 풍선을 찾아 친구들에게 하나씩 선으로 이어 주세요.

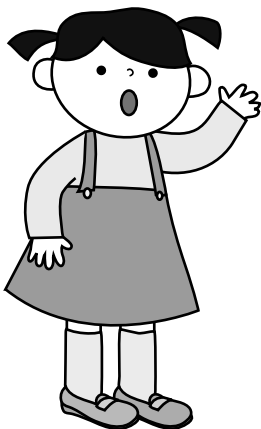
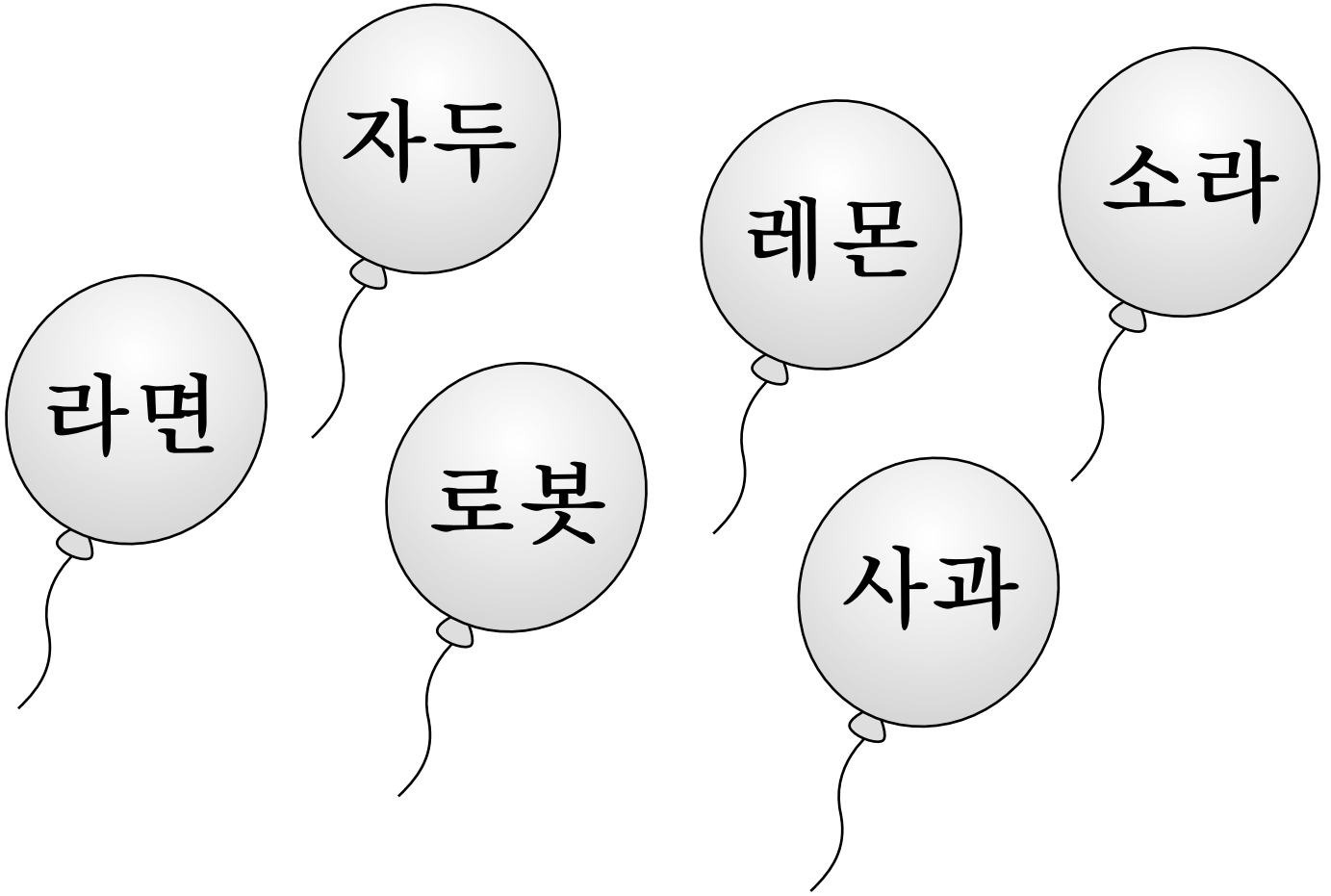

A

한글 [자음 익히기]

ㅁ, ㅂ 익히기 ①

◆ ‘ㅁ’ 이 되도록 선을 그어 보세요.

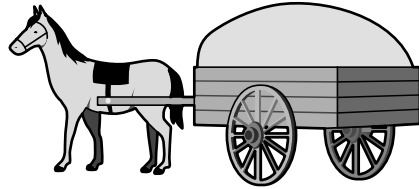
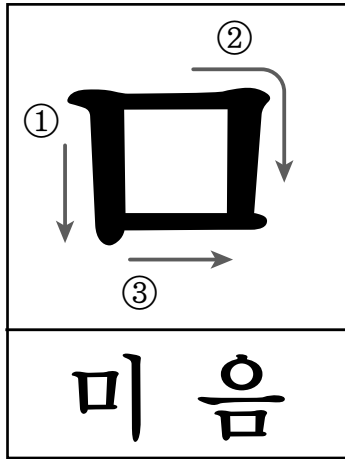

마차

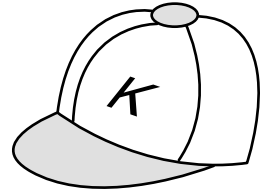

모자

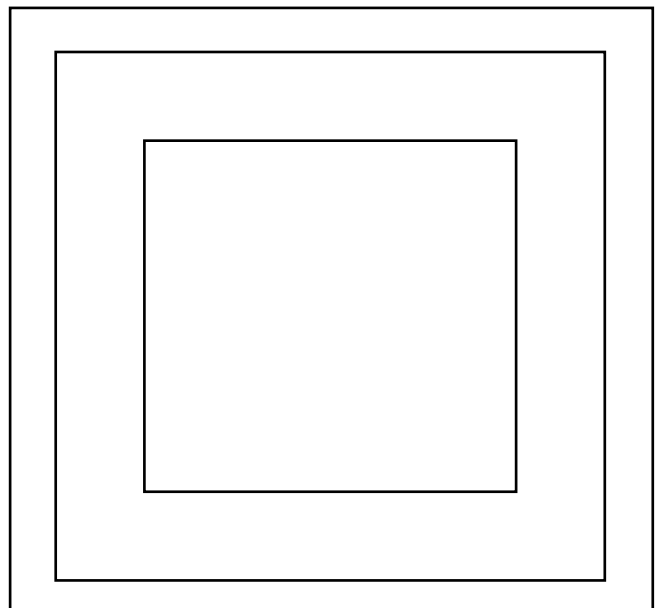
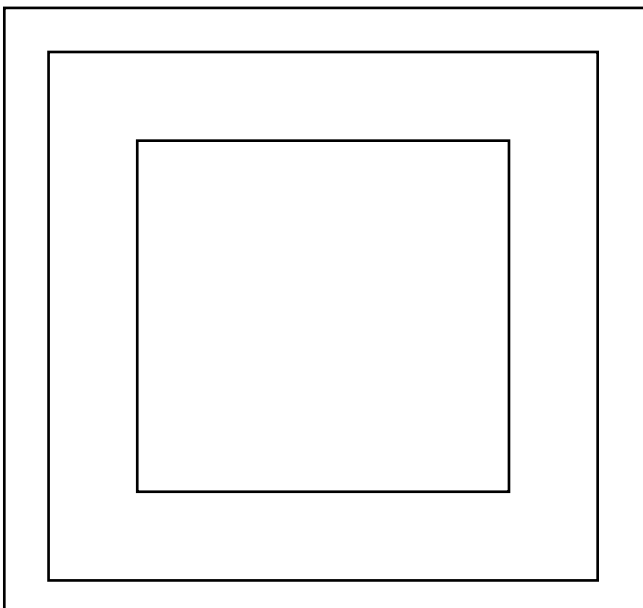
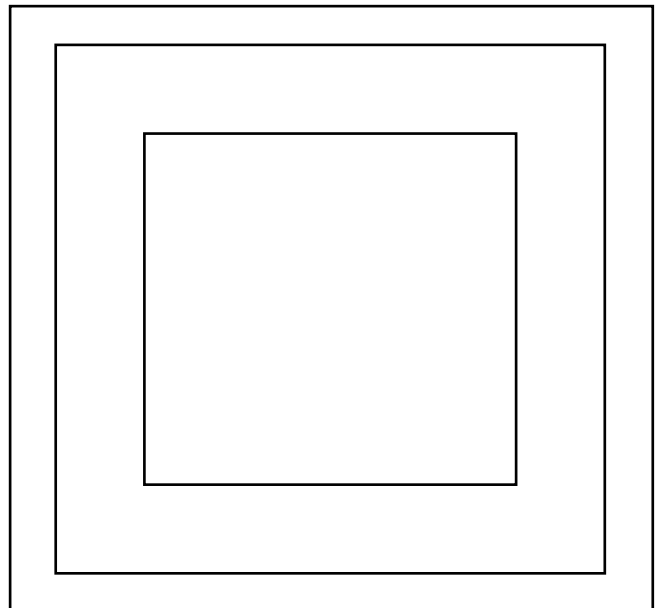
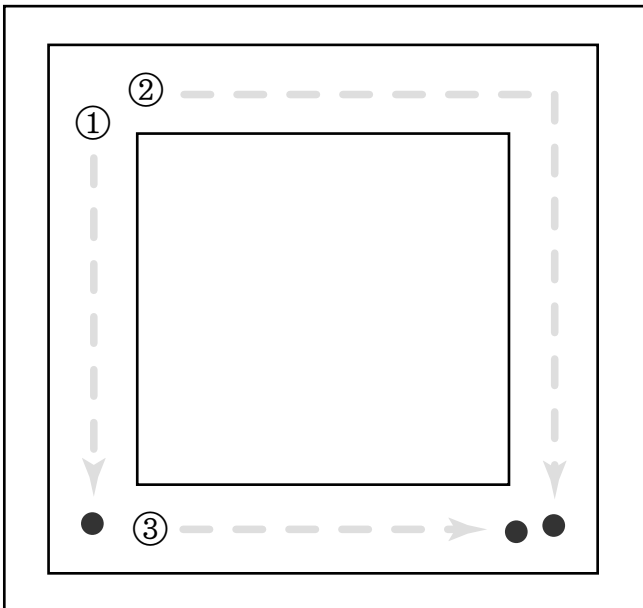





A

한글

[자음 익히기]

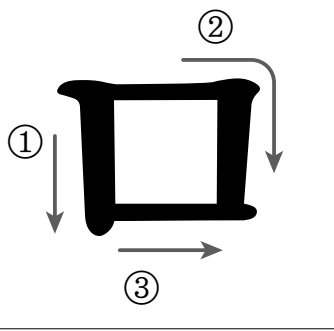
ㅁ, ㅂ 익히기 ②

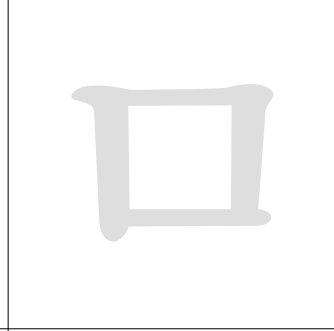
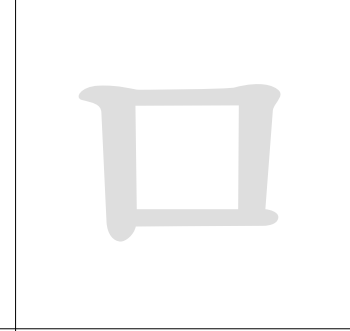
◆ ‘ㅁ’ 을 큰 소리로 읽으면서 써 보세요.

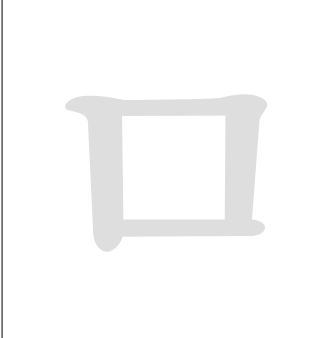
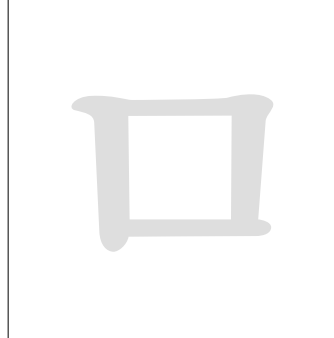
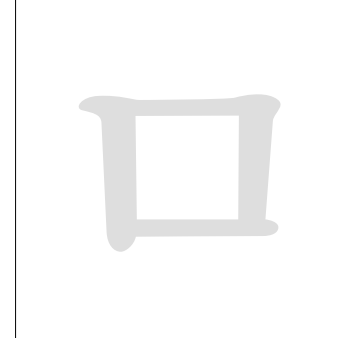

A

한글 [자음 익히기]

ㅁ, ㅂ 익히기 ③

◆ 'ㅂ' 이 되도록 선을 그어 보세요.

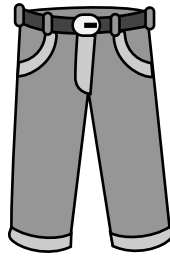
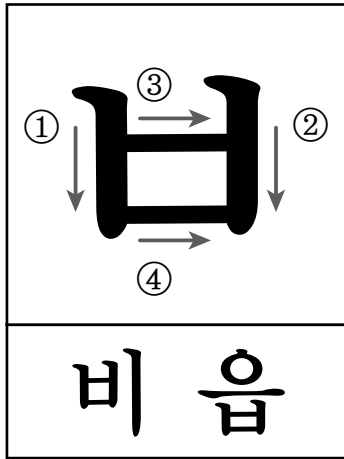

바지



버섯

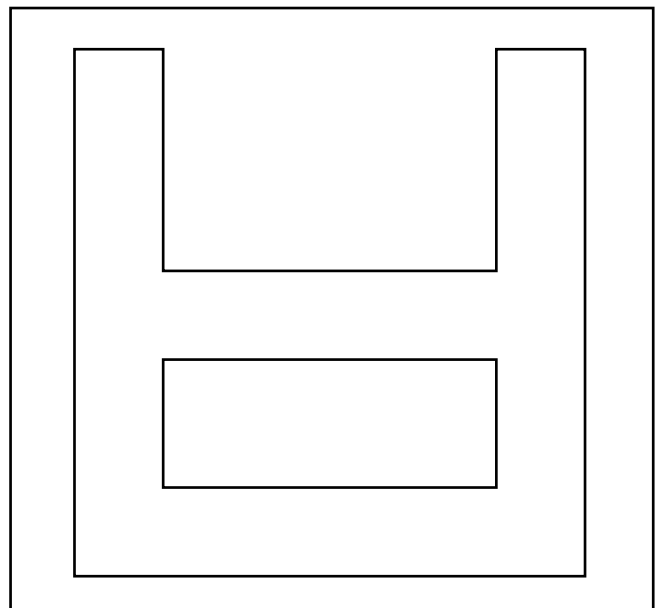
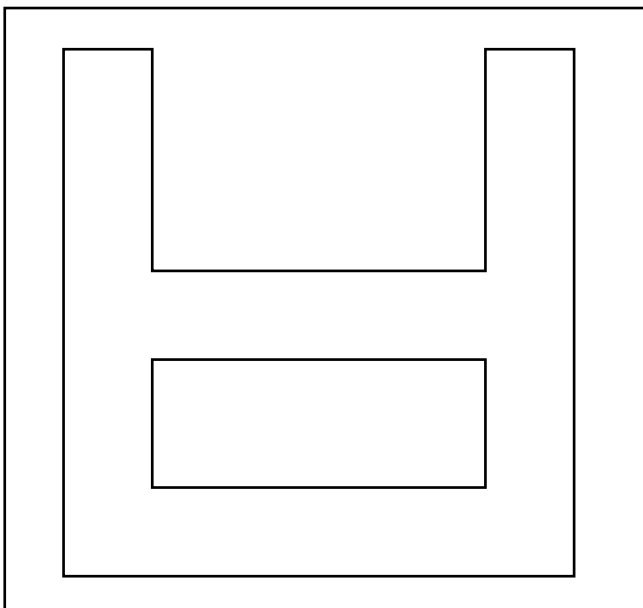
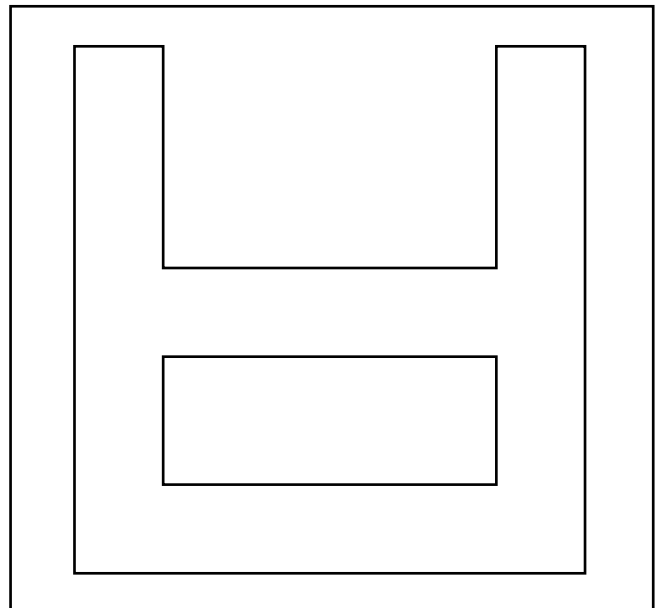
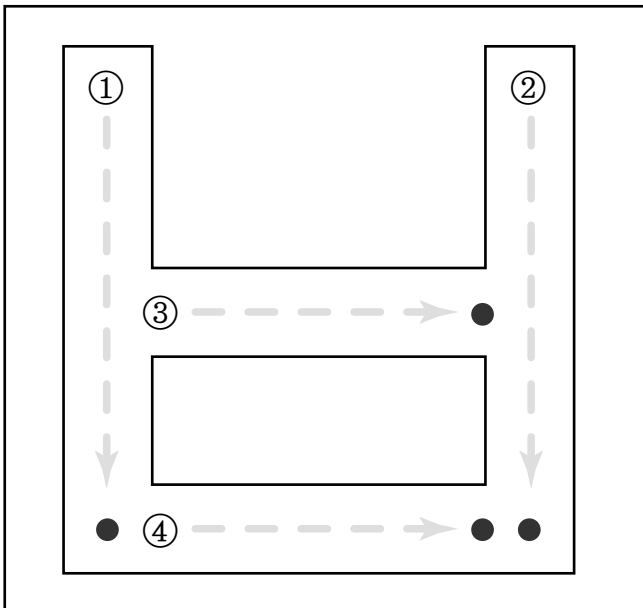







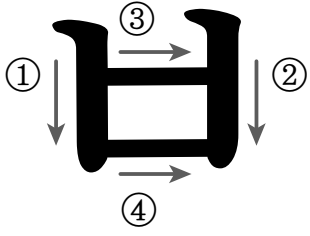

A

한글

[자음 익히기]

ㅁ, ㅂ 익히기 ④

◆ ‘ㅂ’ 을 큰 소리로 읽으면서 써 보세요.

A**한글****[자음 익히기]****ㅁ, ㅂ 익히기 ⑤**

◆ 첫글자에 'ㅁ' 이 들어간 낱말을 찾아 ○를 그려 보세요.

**바다****마늘****수박****치약****기차****매미****모기****로봇****머리**

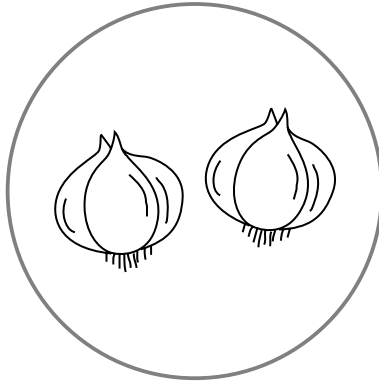
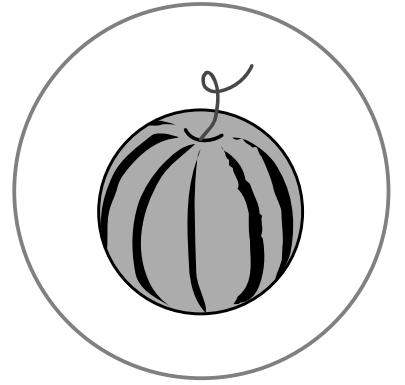
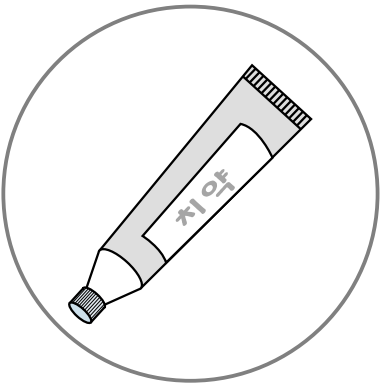
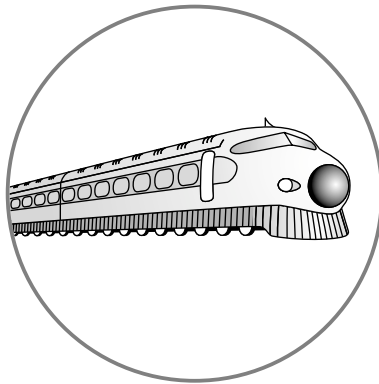
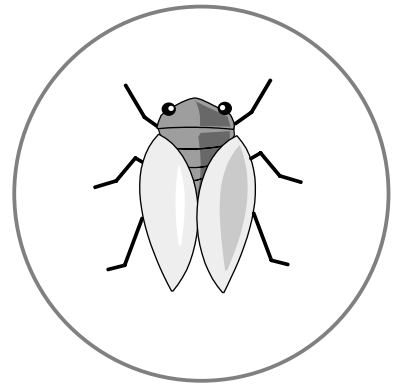
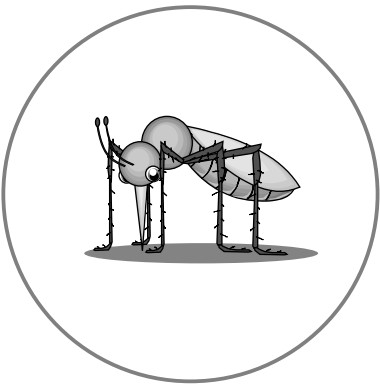
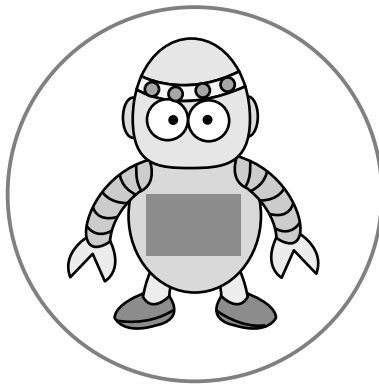
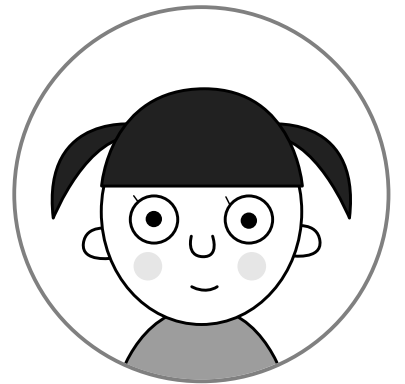
A**한글****[자음 익히기]****ㅁ, ㅂ 익히기 ⑥**

첫글자에 'ㅂ' 이 들어간 낱말을 찾아 ○를 그려 보세요.

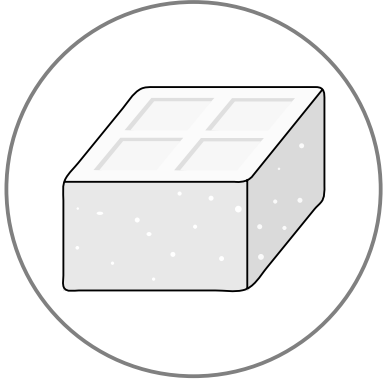
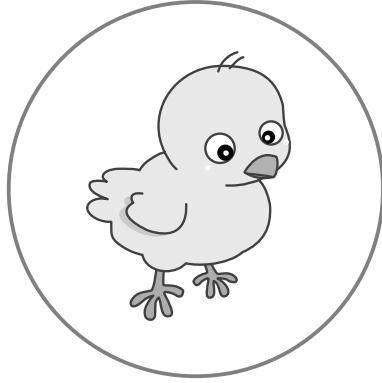
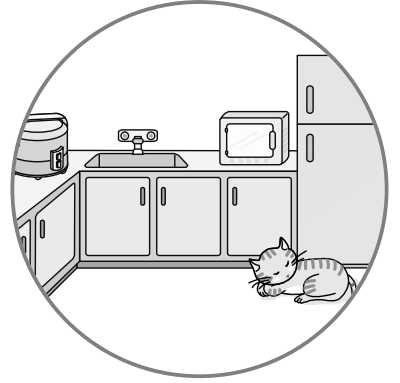
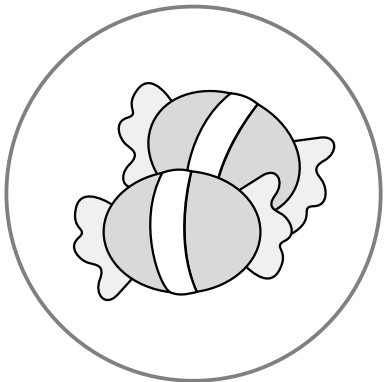
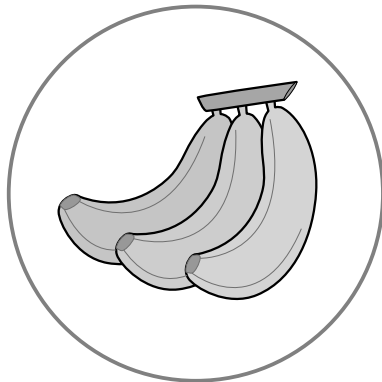
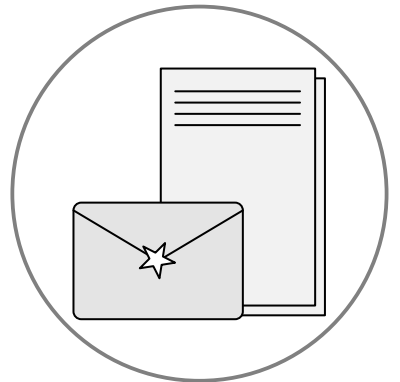
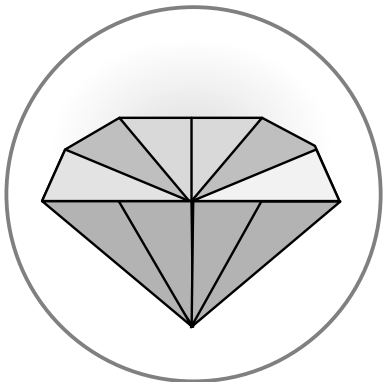
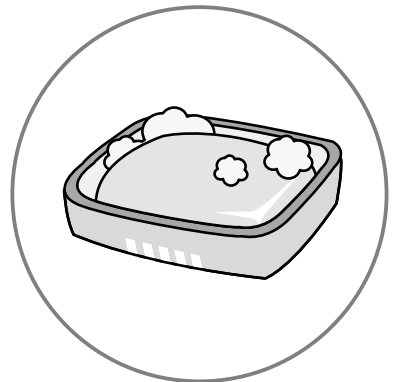
**두부****병아리****부엌****사탕****바나나****편지****보석****마이크****비누**

A

한글

[자음 익히기]

ㄱ~ㅂ 익히기 ①

◆ 그림의 이름과 첫소리를 찾아 선으로 이어 보세요.

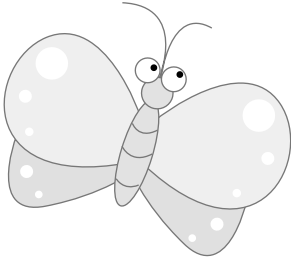

•

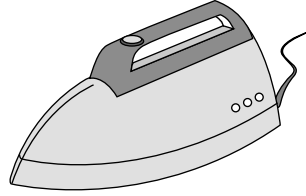

•

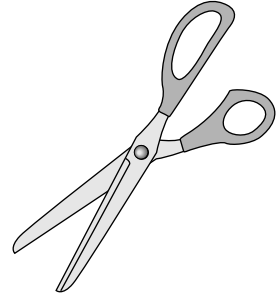

•

•

가위

•

•

다리미

•

•

나비

•

•

ㄴ

•

ㄱ

•

ㄷ

A

한글

[자음 익히기]

ㄱ~ㅂ 익히기 ②

그림의 이름과 첫소리를 찾아 선으로 이어 보세요.

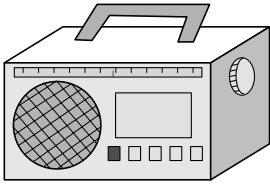

•

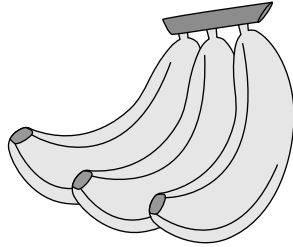

•

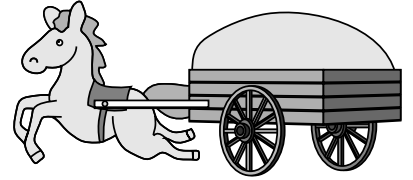

•

•

라디오

•

•

마차

•

•

바나나

•

•

ㅂ

•

ㄱ

•

ㅁ

A

한글

[자음 익히기]

ㄱ~ㄷ 익히기 ③

◆ ㄱ~ㄷ을 어떻게 읽는지 찾아 선으로 잇고, 따라 써 보세요.

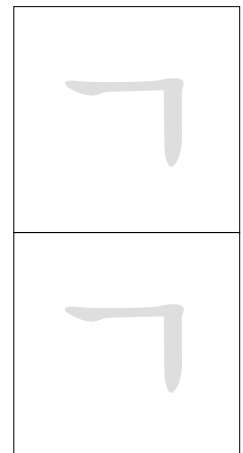
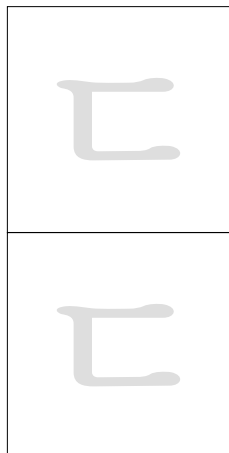
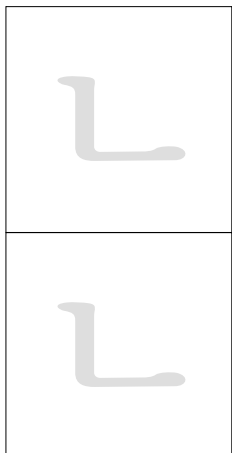
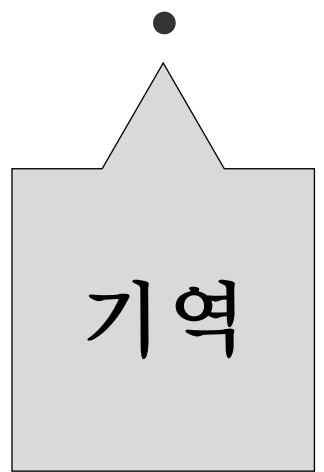
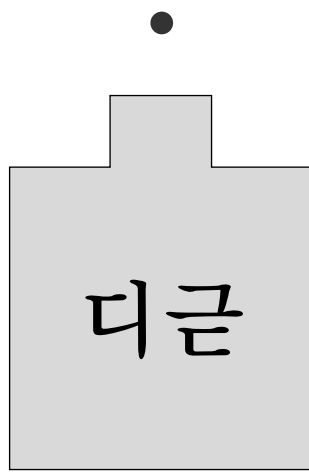
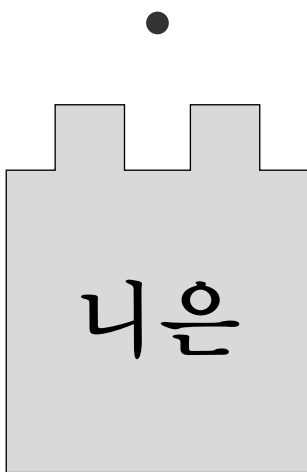
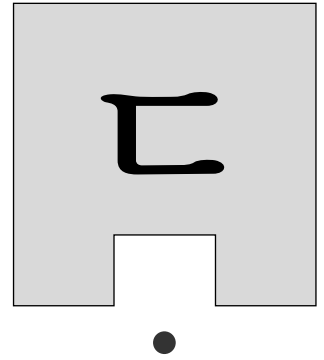
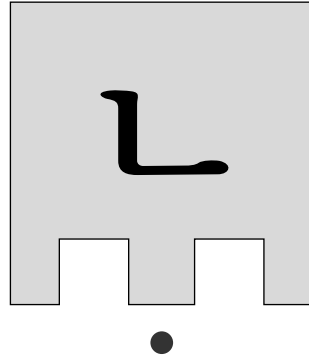
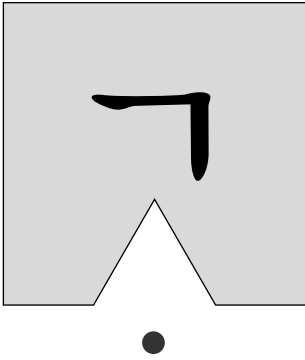

A

한글 [자음 익히기]

ㄱ~ㅂ 익히기 ④

📖 ㄱ~ㅂ을 어떻게 읽는지 찾아 선으로 잇고, 따라 써 보세요.

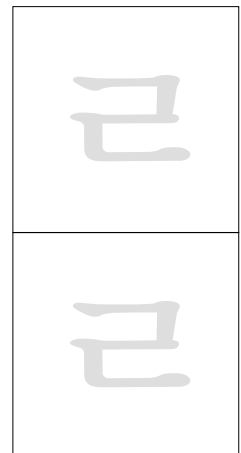
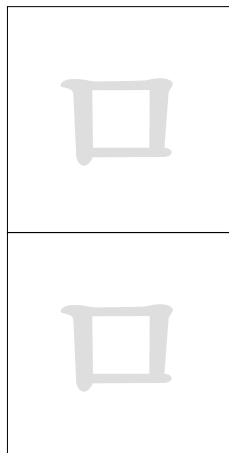
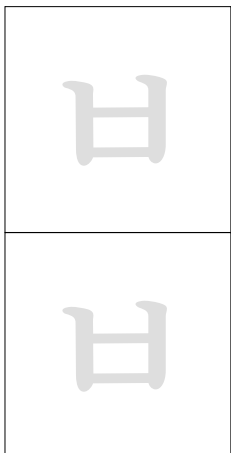
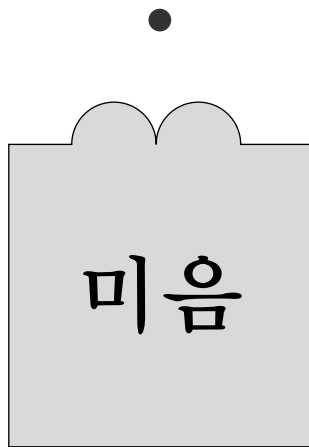
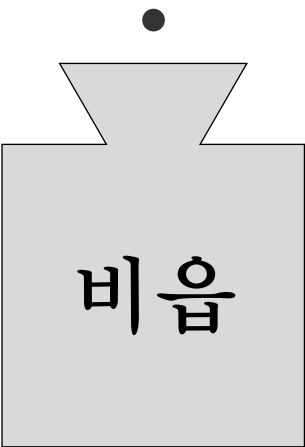
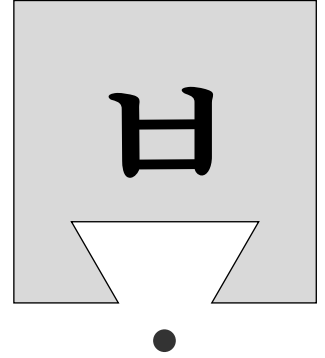
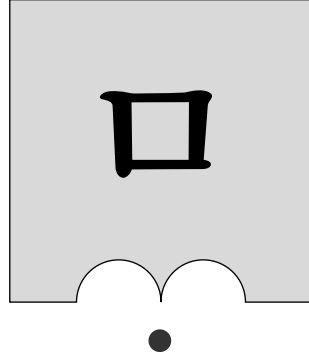
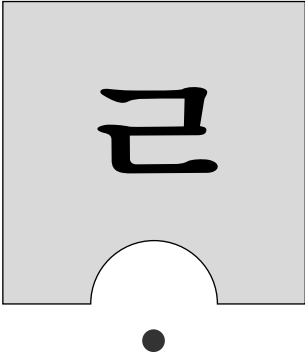

A**한글****[자음 익히기]****ㄱ~ㅂ 익히기 ⑤**

◆ 첫글자에 왼쪽의 낱자가 들어 있는 낱말에 모두 ○를 그려 보세요.



코알라



구두



강아지

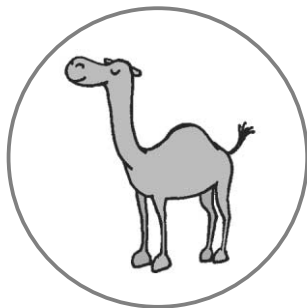
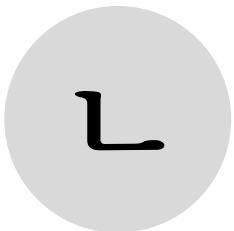

낙타



나팔

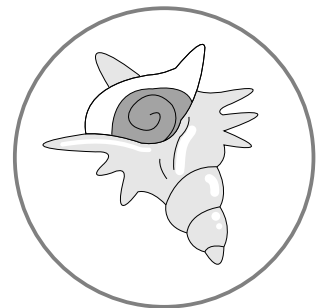

소라

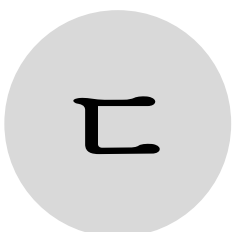

다람쥐

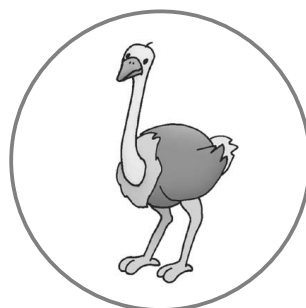

타조

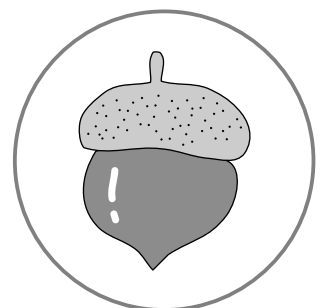

도토리

A**한글** [자음 익히기]

ㄱ~ㅂ 익히기 ⑥

첫글자에 왼쪽의 낱자가 들어 있는 낱말에 모두 ○를 그려 보세요.

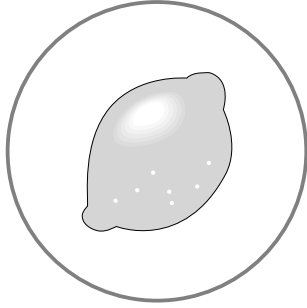

레몬

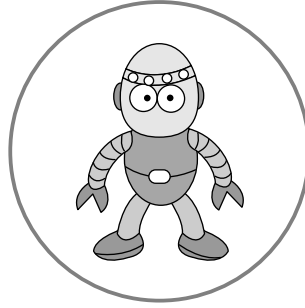

로봇

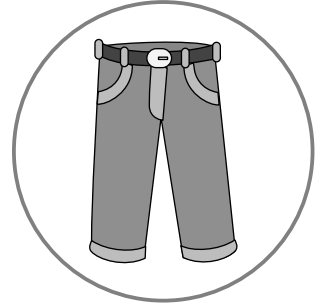

바지

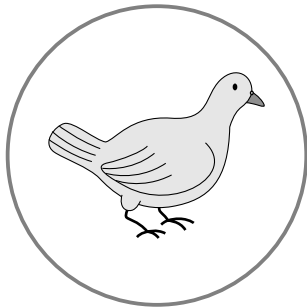
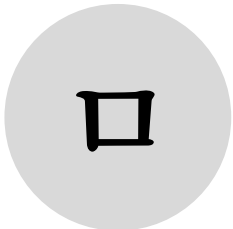

비둘기

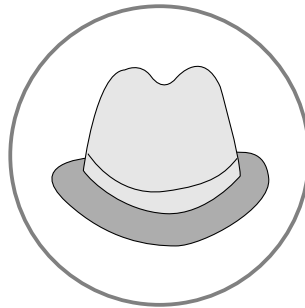

모자

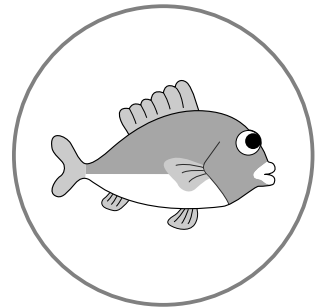

물고기

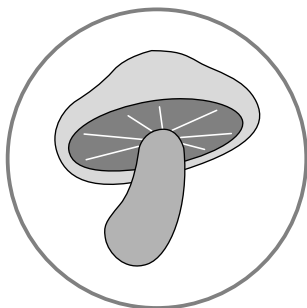

버섯

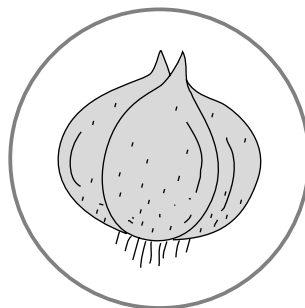

마늘

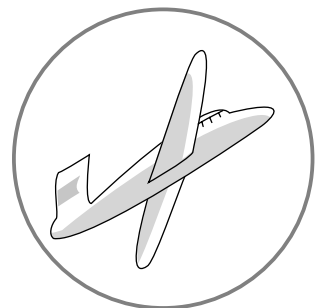

비행기

A**한글****[자음 익히기]****ㄱ~ㅂ 익히기 ⑦**

◆ <보기>에서 알맞은 날자를 찾아 써 넣어 낱말을 완성해 보세요.

**보
기**

ㄱ

ㄴ

ㄷ

ㄹ

ㅁ

ㅂ

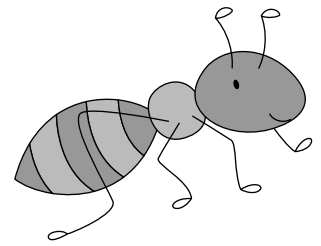
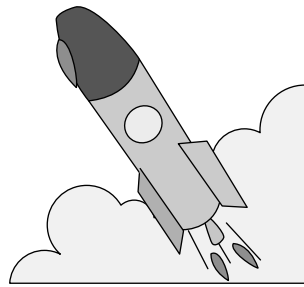
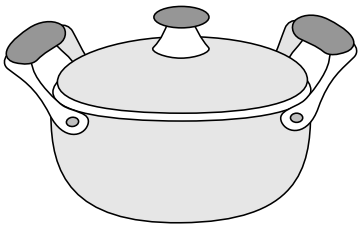

ㅅㅂ비

ㄴ켓

ㅁ미

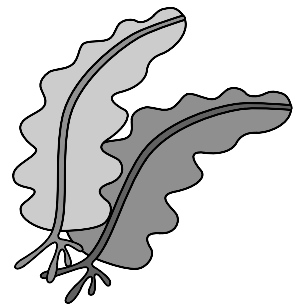
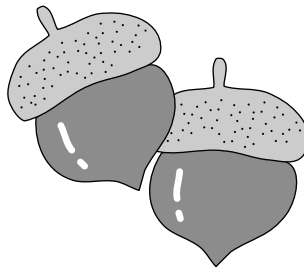
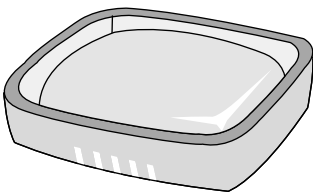

이누

ㄴ토리

이역

A

한글

[자음 익히기]

ㄱ~ㅂ 익히기 ⑧

❖ <보기>에서 알맞은 낱자를 찾아 써 넣어 낱말을 완성해 보세요.

보기

ㄱ

ㄴ

ㄷ

ㄹ

ㅁ

ㅂ

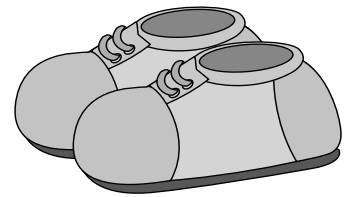
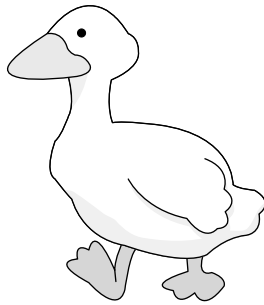
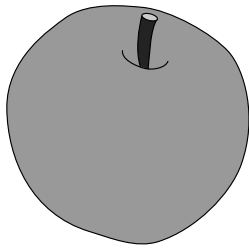

사과

오이

신발

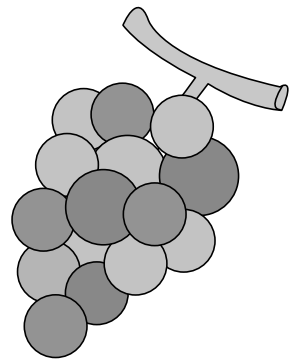
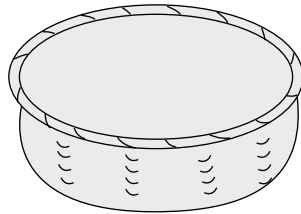
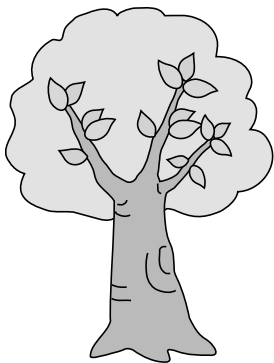

나무

바구니

포도

A

한글

[자음 익히기]

ㅅ, ㅇ 익히기 ①

◆ ‘ㅅ’ 이 되도록 선을 그어 보세요.

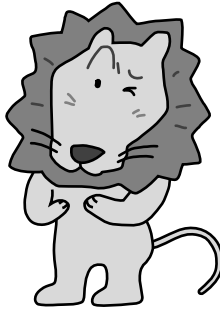
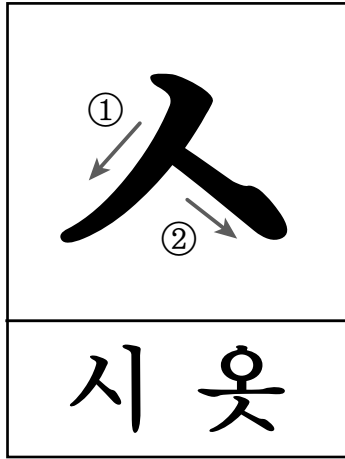

사자

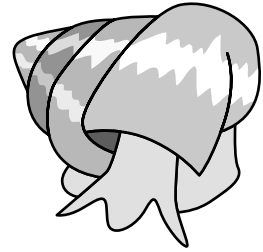



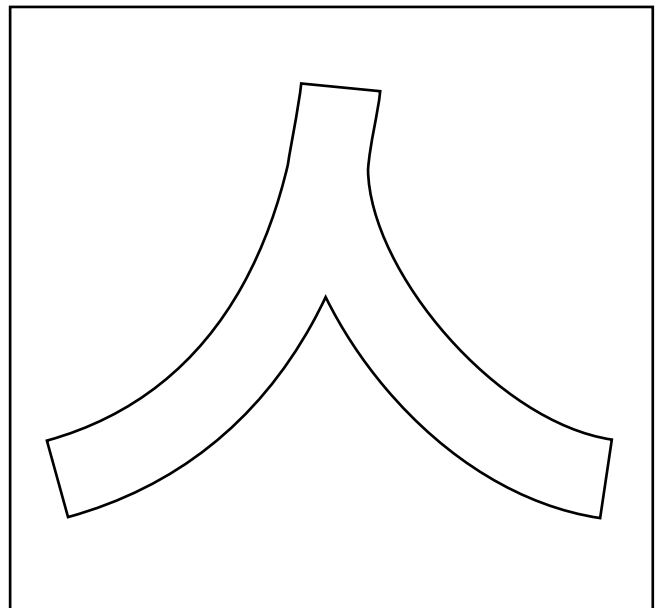
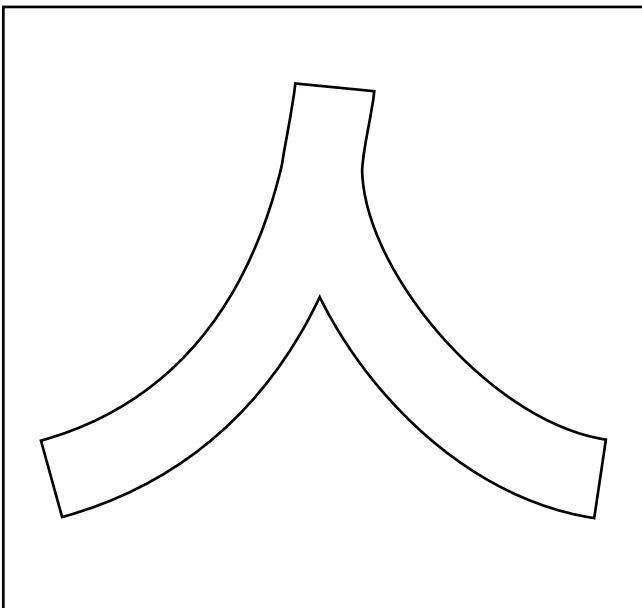
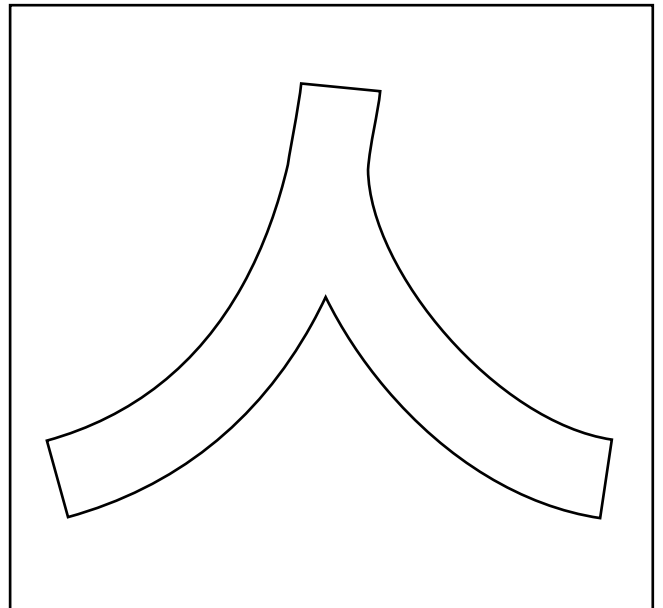
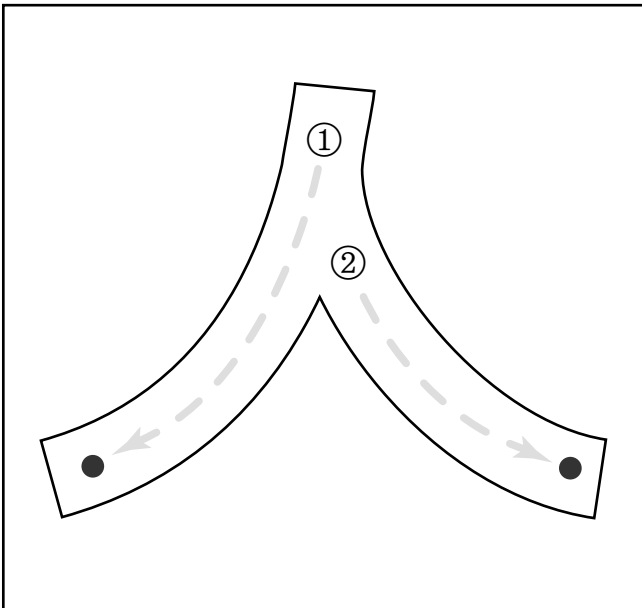



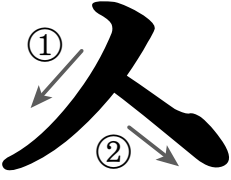

소라



A**한글****[자음 익히기]****ㅅ, ㅇ 익히기 ②**

◆ ‘ㅅ’을 큰 소리로 읽으면서 써 보세요.

A

한글

[자음 익히기]

ㅅ, ㅇ 익히기 ③

◆ ‘ㅇ’ 이 되도록 선을 그어 보세요.

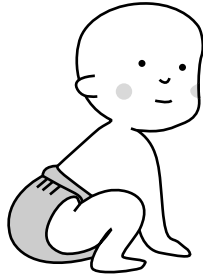
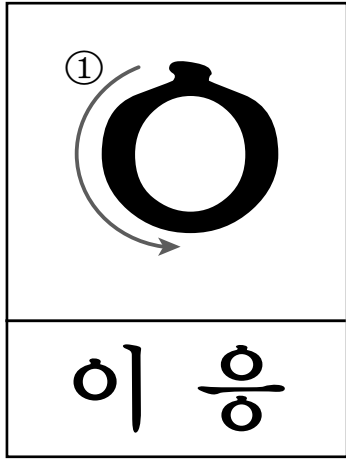

아기

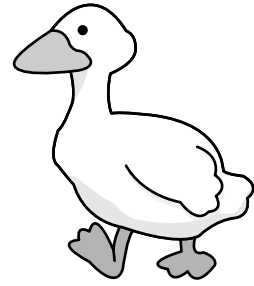



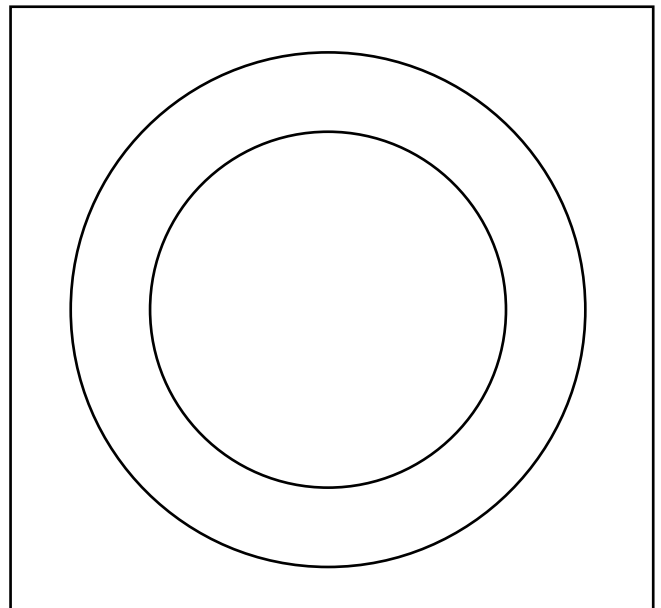
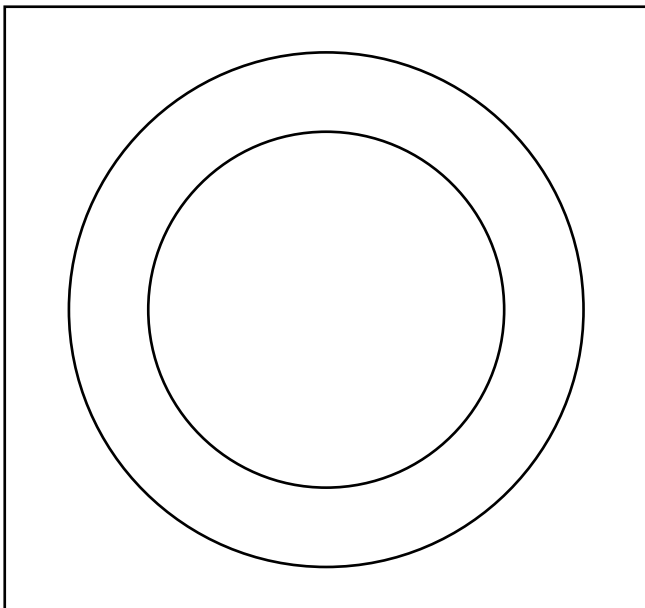
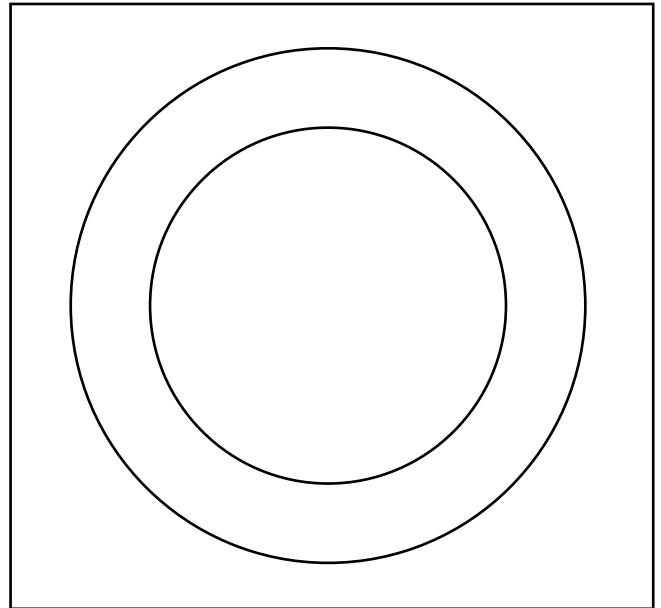
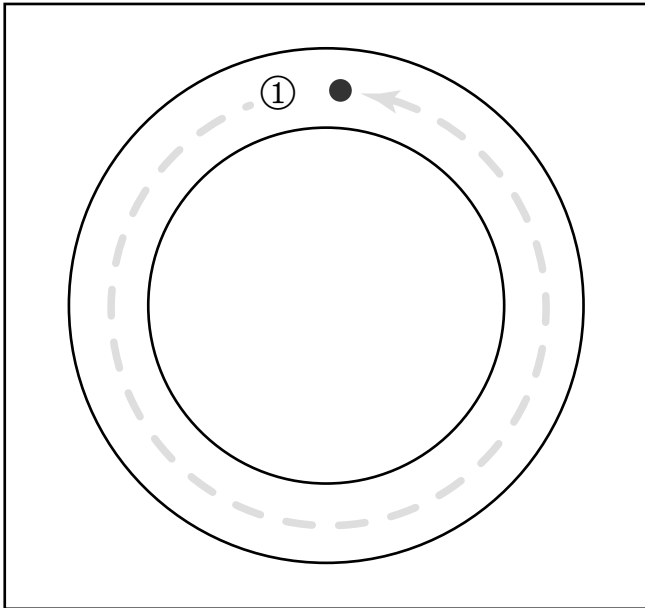



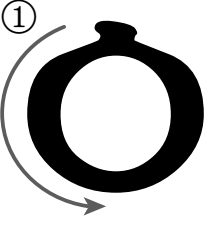

오리



A**한글****[자음 익히기]****ㅅ, ㅇ 익히기 ④**

📖 'ㅇ' 을 큰 소리로 읽으면서 써 보세요.

A

한글

[자음 익히기]

ㅅ, ㅇ 익히기 ⑤

◆ ‘ㅅ’ 이 들어간 낱말을 따라가 보세요.



A

한글

[자음 익히기]

ㅅ, ㅇ 익히기 ⑥

◆ ‘ㅇ’ 이 들어간 꽃만 예쁘게 색칠해 보세요.

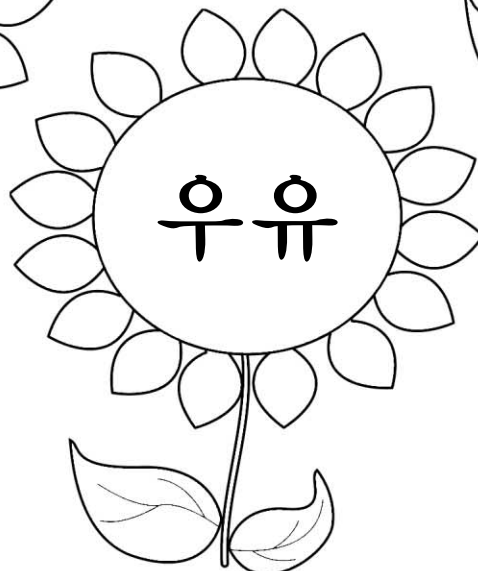

A

한글

[자음 익히기]

ㅈ, ㅊ 익히기 ①

◆ ‘ㅈ’ 이 되도록 선을 그어 보세요.

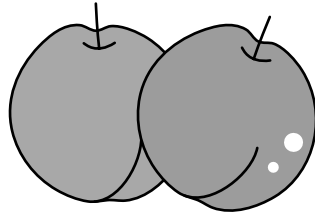
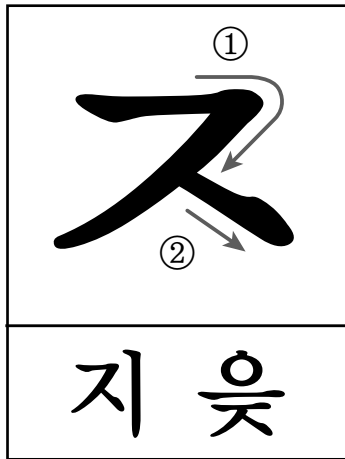

자두

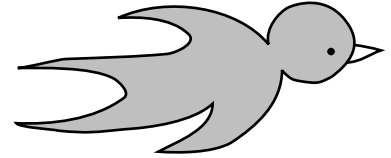



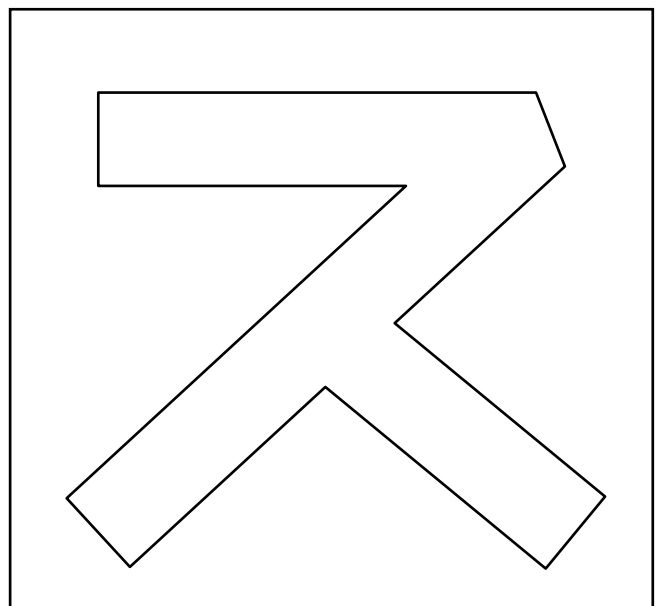
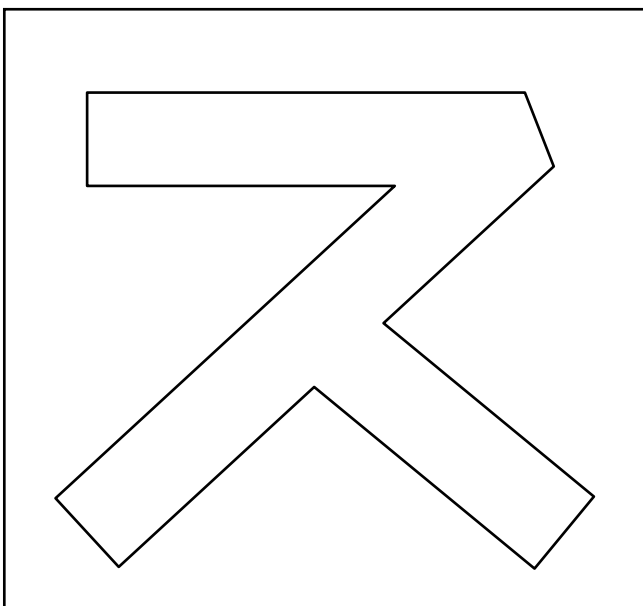
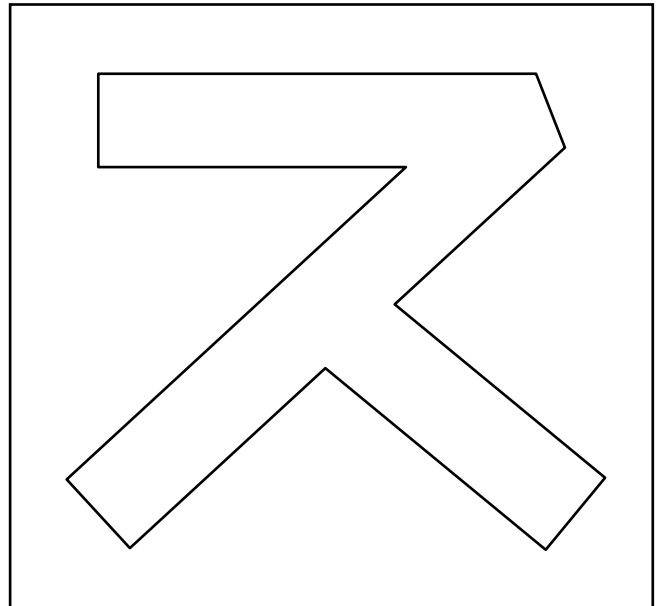
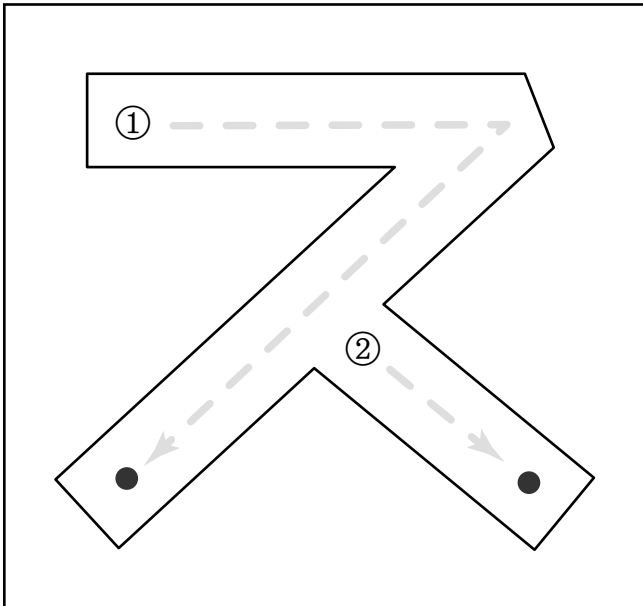



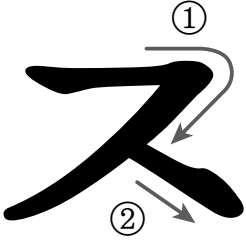

제비



A**한글****[자음 익히기]****ㅈ, ㅊ 익히기 ②**

◆ ‘ㅈ’을 큰 소리로 읽으면서 써 보세요.

			
			

A

한글 [자음 익히기]

ㅈ, ㅊ 익히기 ③

◆ ‘ㅈ’ 이 되도록 선을 그어 보세요.

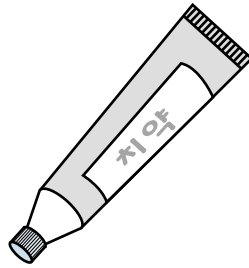
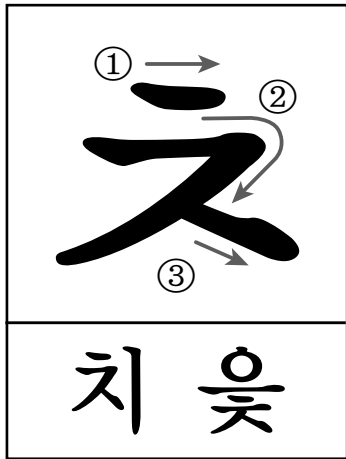

치약



양초

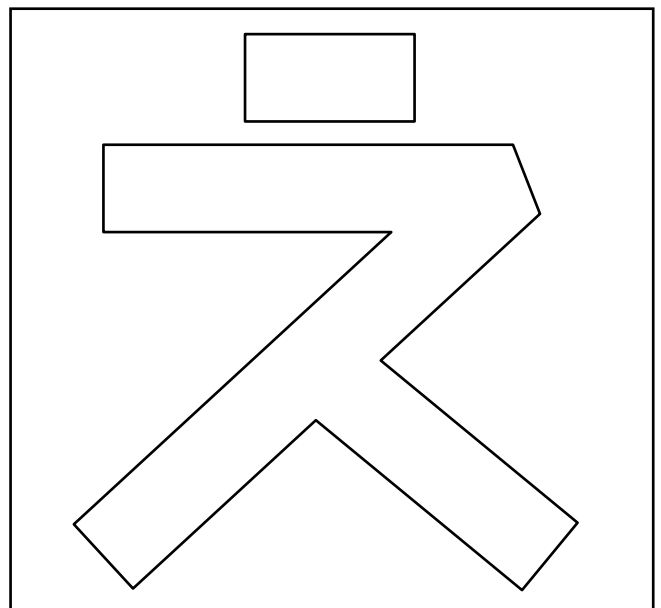
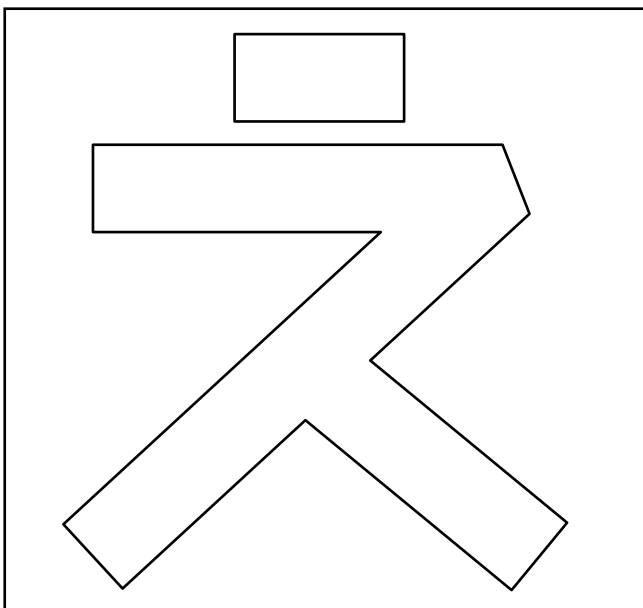
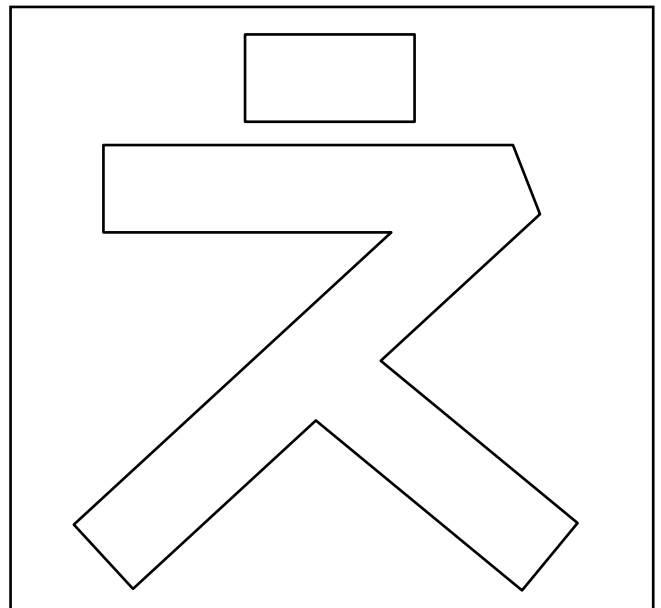
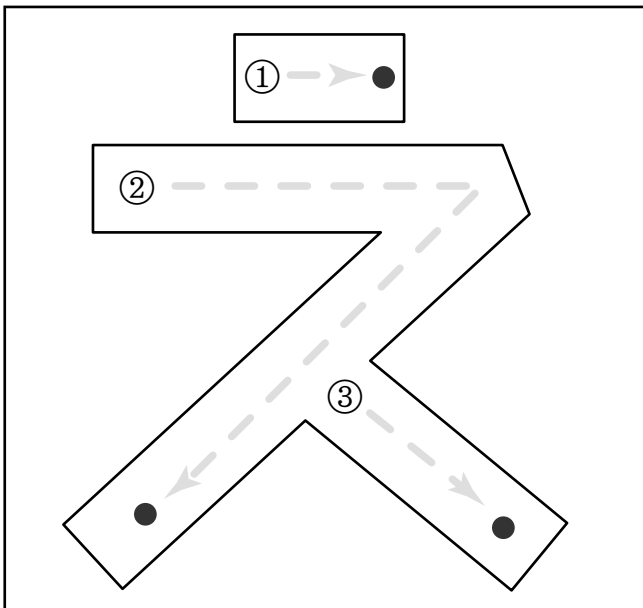







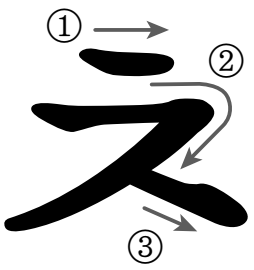

A

한글

[자음 익히기]

ㅈ, ㅊ 익히기 ④

◆ ‘ㅈ’을 큰 소리로 읽으면서 써 보세요.

A

한글

[자음 익히기]

ㅈ, ㅊ 익히기 ⑤

◆ ‘ㅈ’ 이 들어간 카드를 들고 있는 동물을 찾아 ○를 그려 보세요.

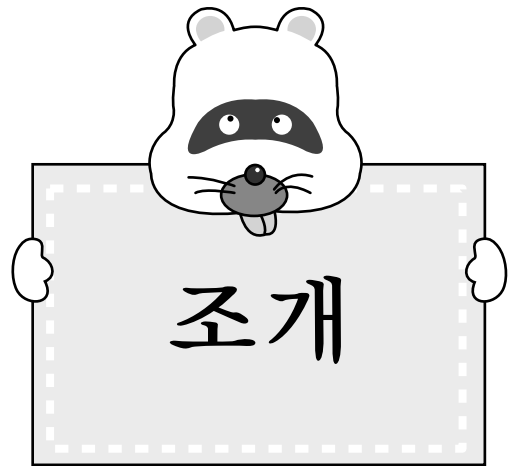
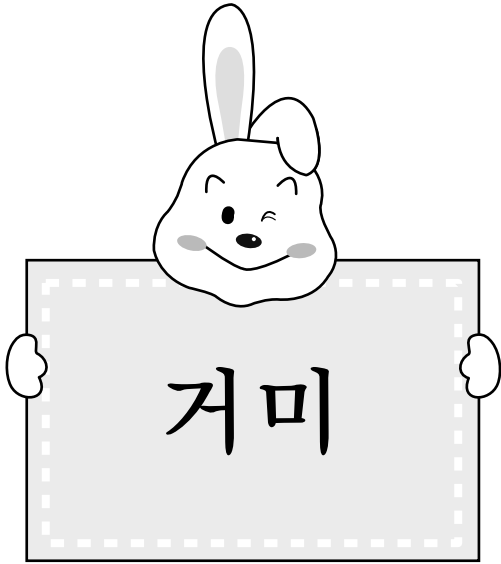

A**한글****[자음 익히기]****ㅈ, ㅊ 익히기 ⑥**

◆ ‘ㅈ’ 이 들어간 사탕을 찾아 ○를 그려 보세요.

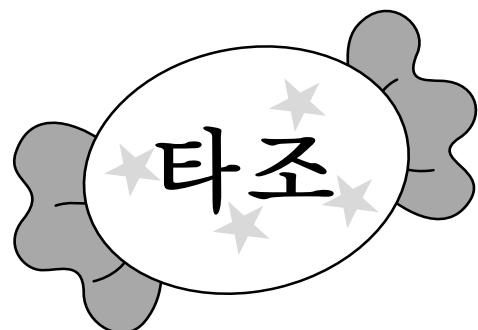
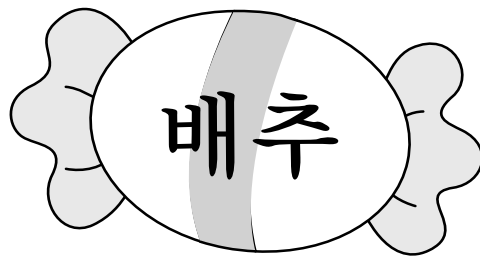
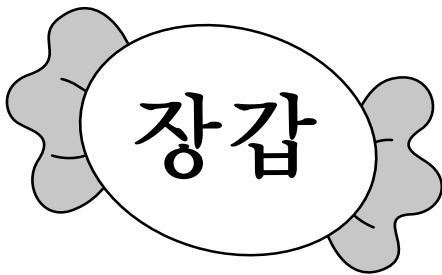
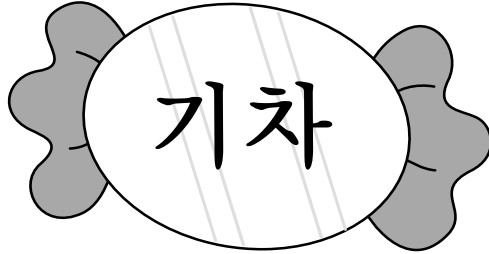

A

한글 [자음 익히기]

ㅋ, ㅌ 익히기 ①

◆ 'ㅋ' 이 되도록 선을 그어 보세요.

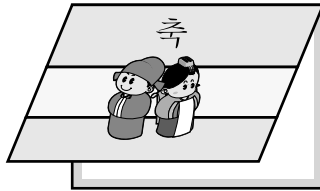
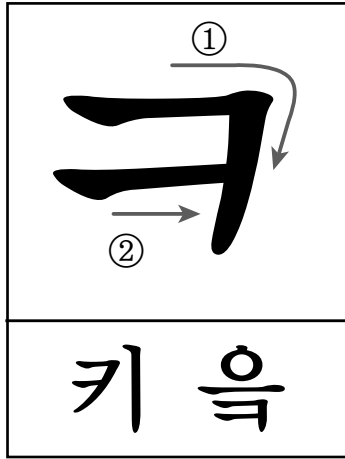

카드

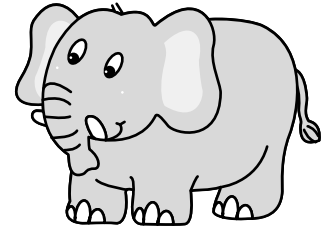



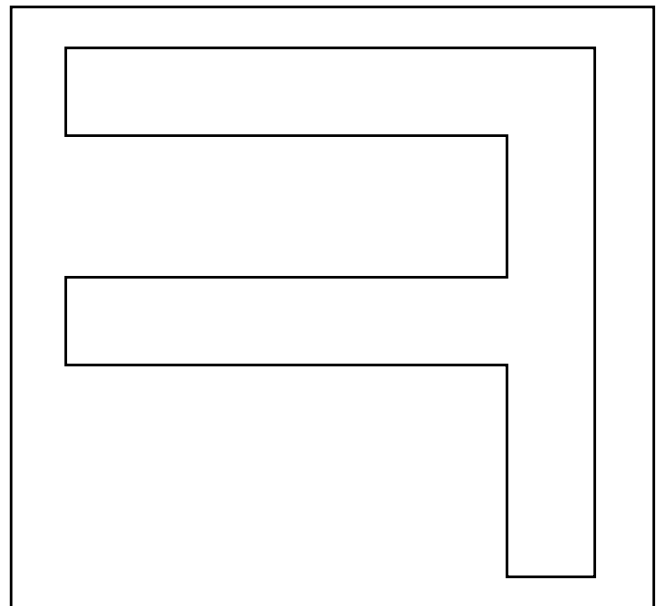
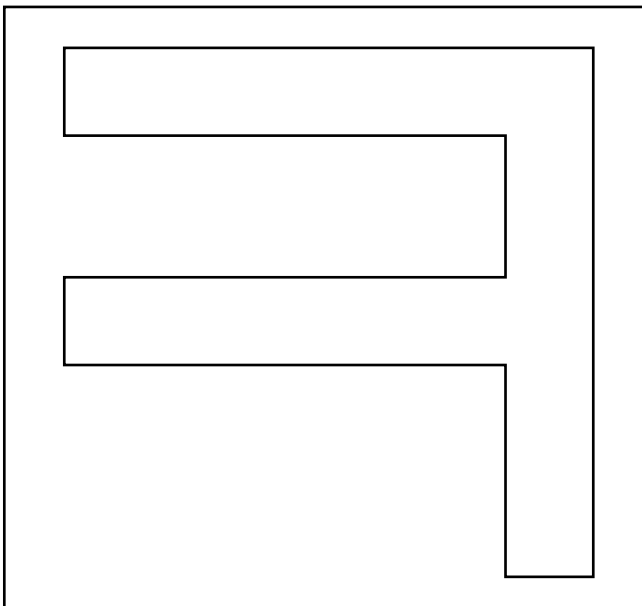
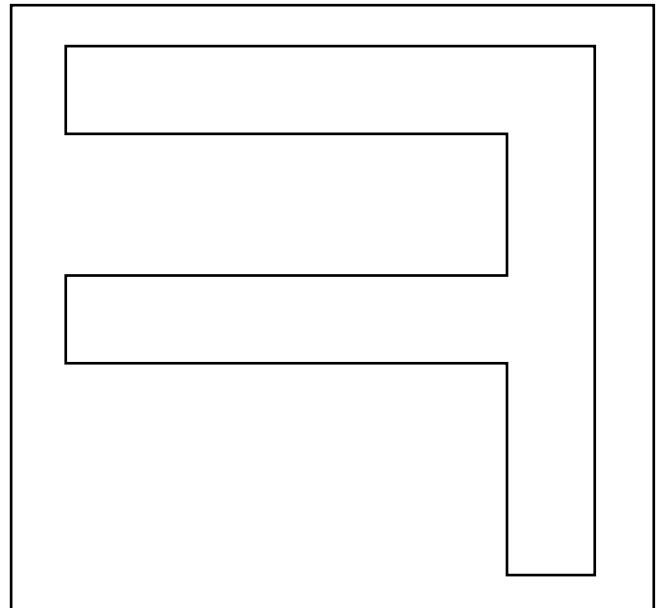
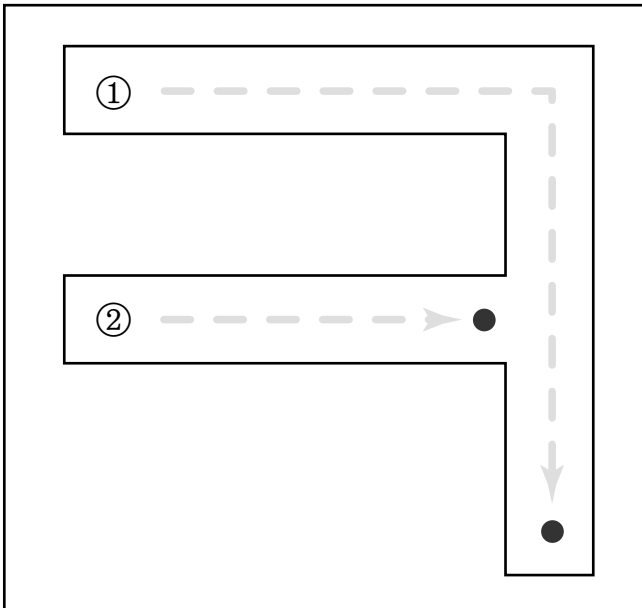



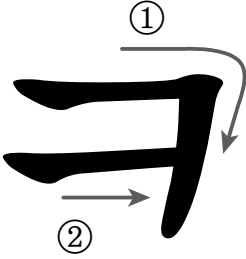

코끼리



A**한글****[자음 익히기]****ㅋ, ㅌ 익히기 ②**

◆ ‘ㅋ’ 을 큰 소리로 읽으면서 써 보세요.

A

한글 [자음 익히기]

ㅋ, ㅌ 익히기 ③

◆ 'ㅌ' 이 되도록 선을 그어 보세요.

티 을

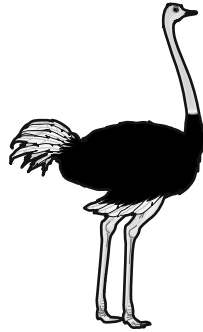



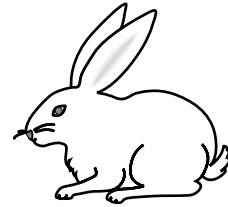





타조

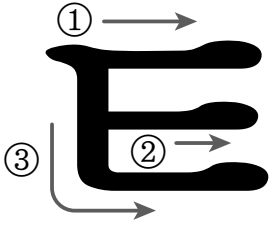

토끼

A**한글****[자음 익히기]****ㅋ, ㅌ 익히기 ④**

 ‘ㅌ’ 을 큰 소리로 읽으면서 써 보세요.

			
			

A**한글**

[자음 익히기]

ㅋ, ㅌ 익히기 ⑤

◆ ‘ㅋ’ 이 들어간 물고기만 예쁘게 색칠해 보세요.

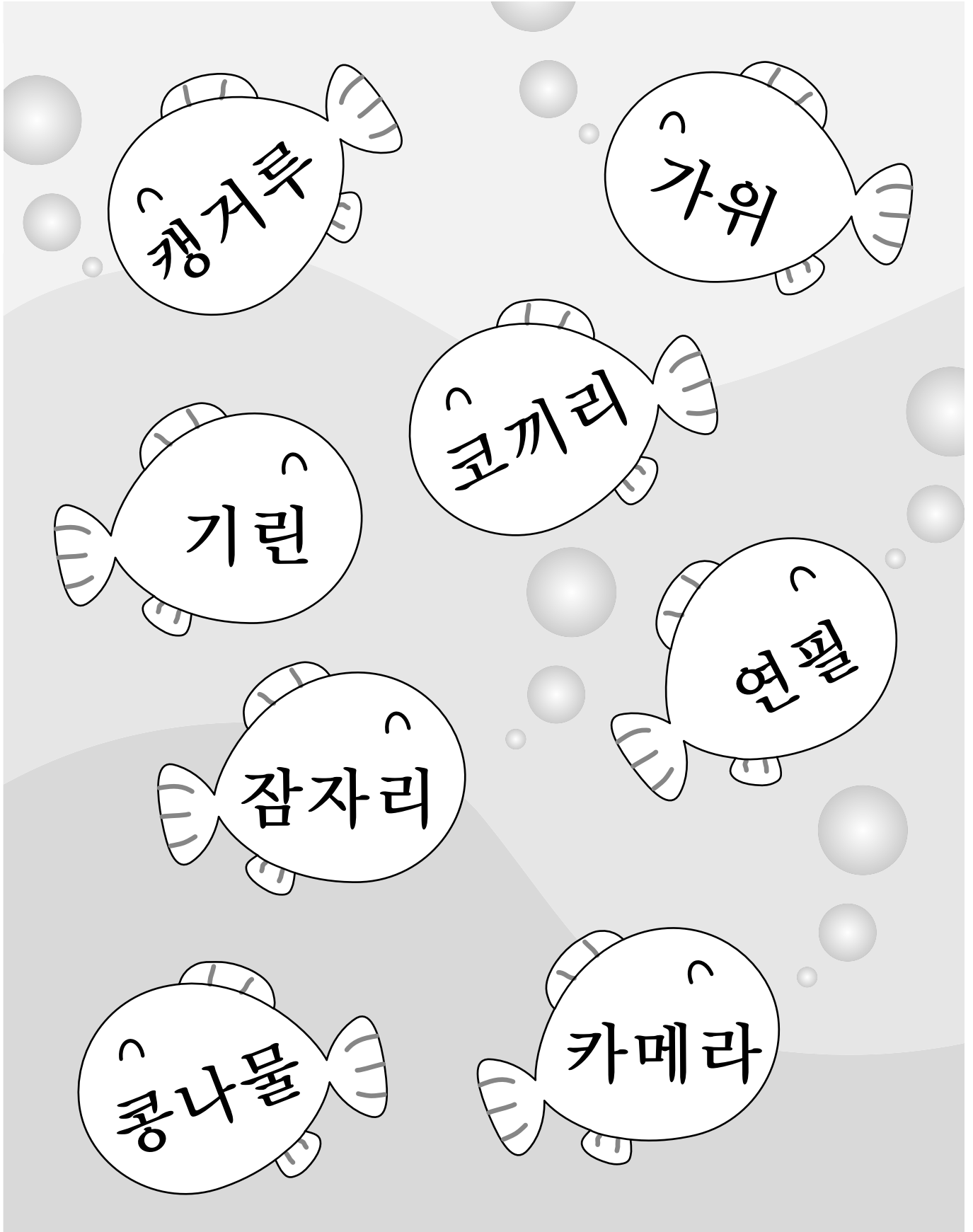

A**한글**

[자음 익히기]

ㅋ, ㅌ 익히기 ⑥

◆ ‘ㅌ’ 이 들어간 사과만 예쁘게 색칠해 보세요.

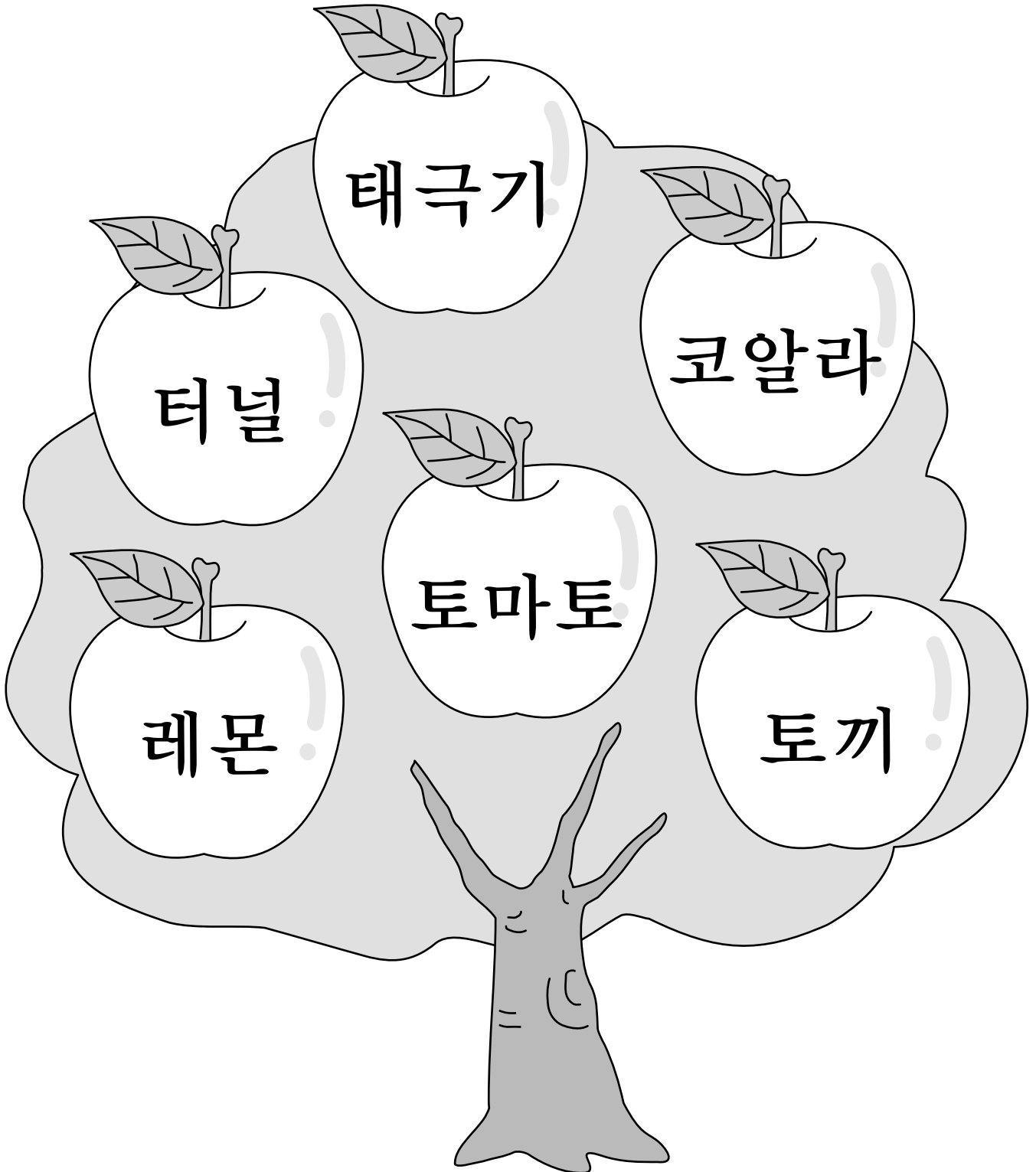

A

한글 [자음 익히기]

ㅍ, ㅎ 익히기 ①

◆ ‘ㅍ’ 이 되도록 선을 그어 보세요.

①
② ③
④

피 효

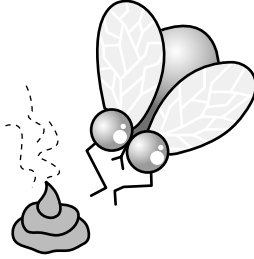

파리

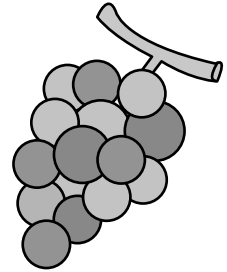

포도

①
② ③
④







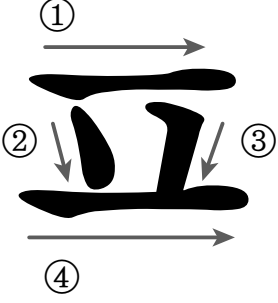

A

한글

[자음 익히기]

ㅍ, ㅎ 익히기 ②

◆ ‘ㅍ’ 을 큰 소리로 읽으면서 써 보세요.

A

한글 [자음 익히기]

ㅍ, ㅎ 익히기 ③

◆ 'ㅎ' 이 되도록 선을 그어 보세요.

히 흥

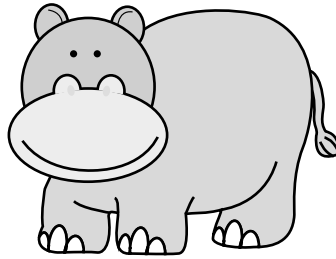

하마

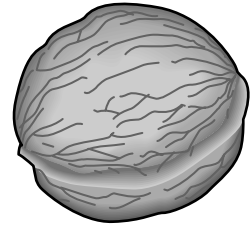

호두

A**한글** [자음 익히기]

ㅍ, ㅎ 익히기 ④

◆ ‘ㅎ’ 을 큰 소리로 읽으면서 써 보세요.

A**한글****[자음 익히기]****ㅍ, ㅎ 익히기 ⑤**

◆ 첫글자에 'ㅍ' 이 들어간 낱말을 찾아 ○를 그려 보세요.

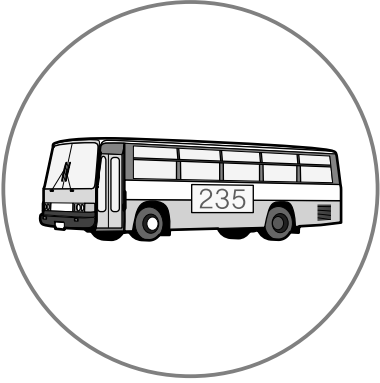
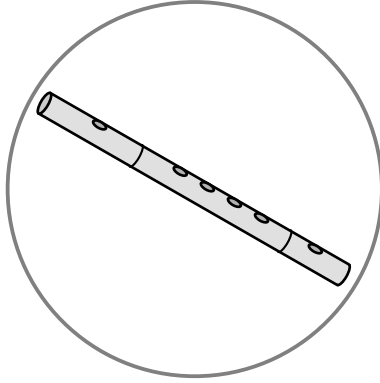
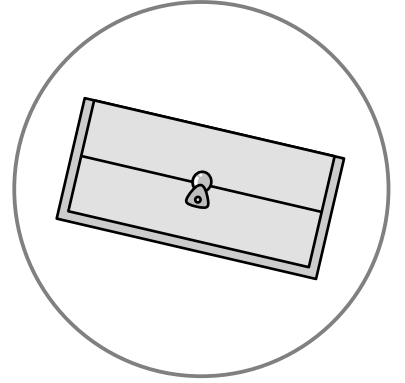
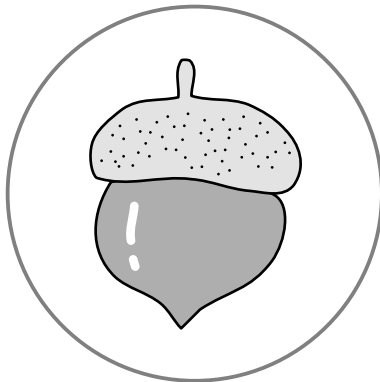
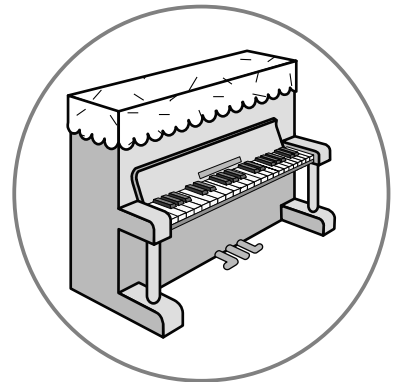
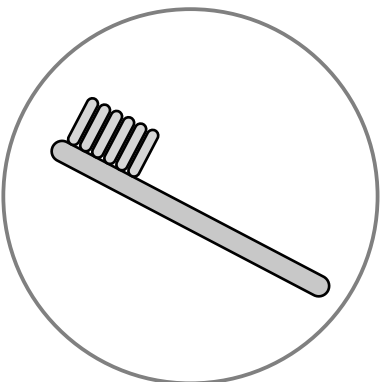
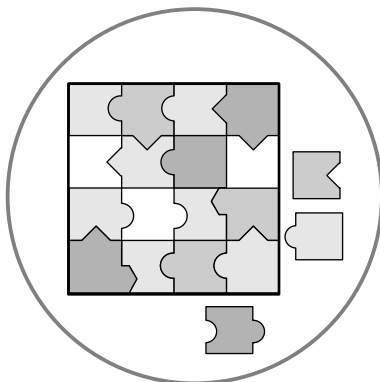
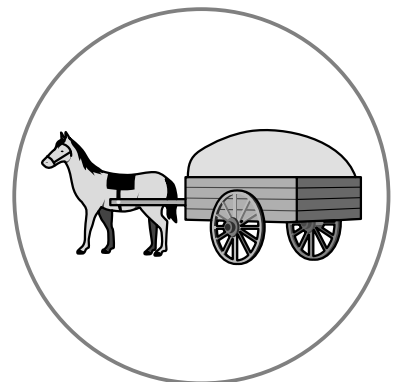
**버스****피리****지갑****파도****도토리****피아노****칫솔****퍼즐****마차**

A**한글** [자음 익히기]

ㅍ, ㅎ 익히기 ⑥

첫글자에 'ㅎ' 이 들어간 낱말을 찾아 ○를 그려 보세요.

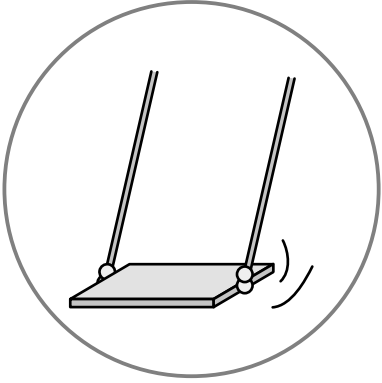

그네

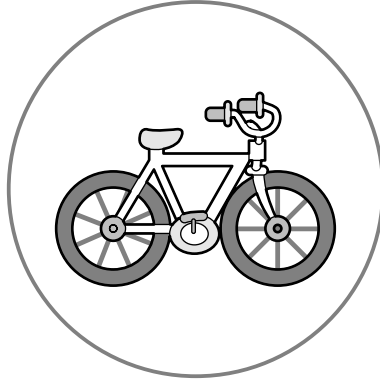

자전거

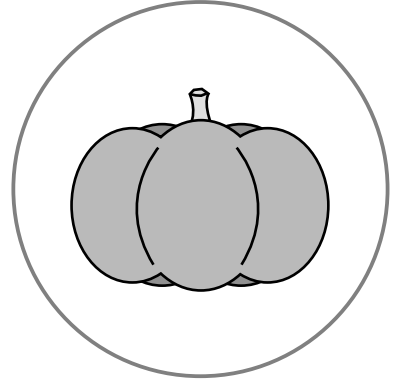

호박

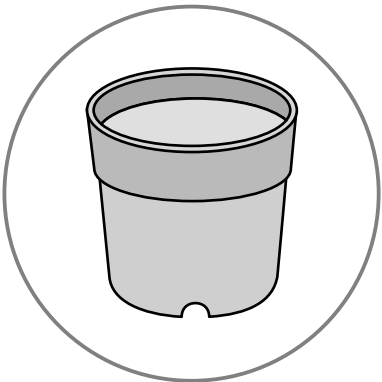

화분

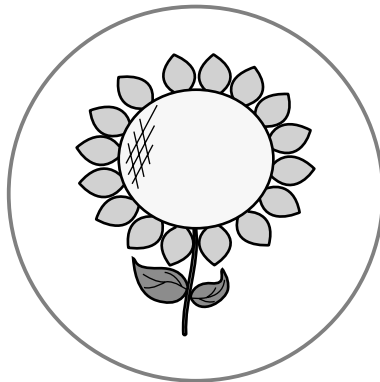

해바라기



우산

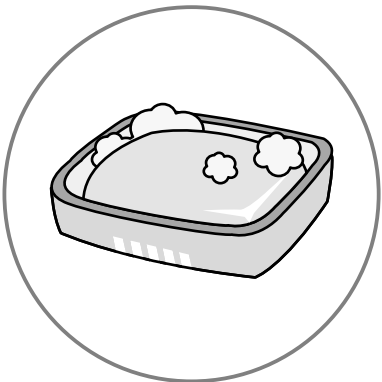

비누

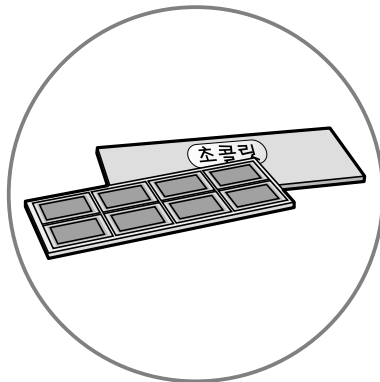

초콜릿



할머니

A**한글****[자음 익히기]****ㅅ~ㅎ 익히기 ①**

그림의 이름과 첫소리를 찾아 선으로 이어 보세요.

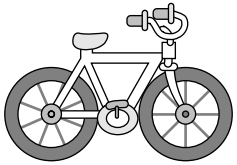

사자

ㅅ



자전거

ㅅ

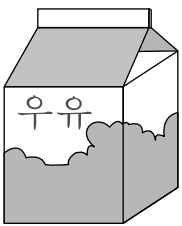

칫솔

ㅅ

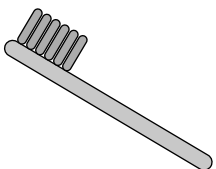

우유

ㅇ

A**한글****[자음 익히기]****ㅅ~ㅎ 익히기 ②**

◆ 그림의 이름과 첫소리를 찾아 선으로 이어 보세요.

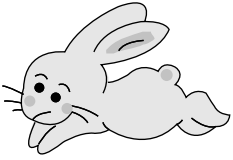

토끼

ㅎ

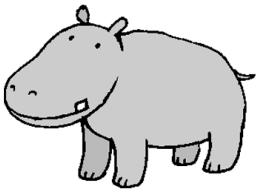

포도

ㅋ

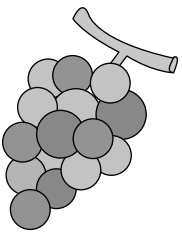

카메라

ㅌ

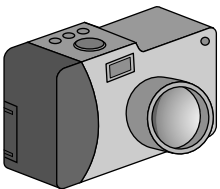

하마

ㅍ

A**한글****[자음 익히기]****ㅅ~ㅎ 익히기 ③**

◆ **ㅅ~ㅎ**을 어떻게 읽는지 찾아 선으로 잇고, 따라 써 보세요.

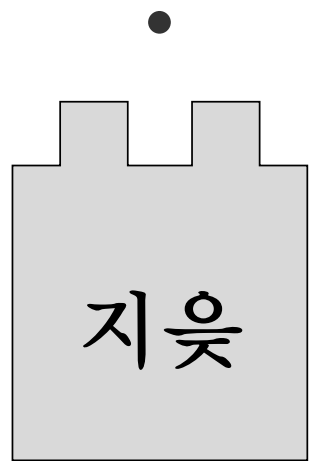
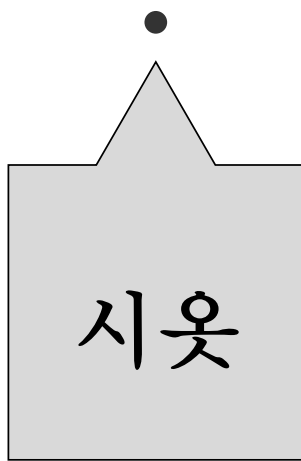
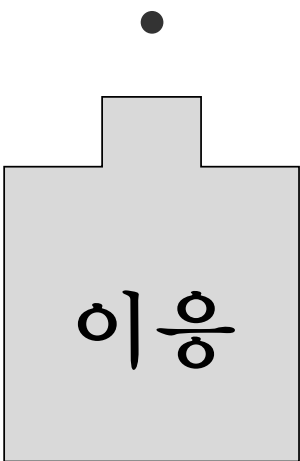
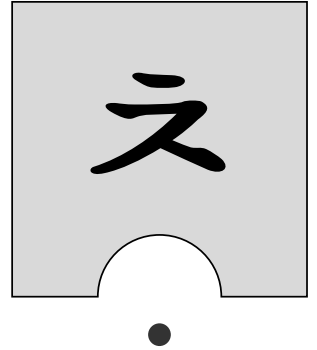
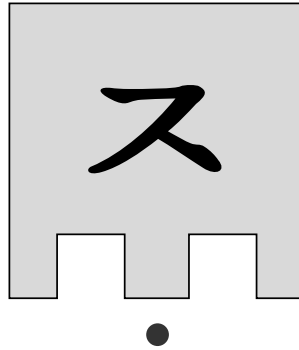
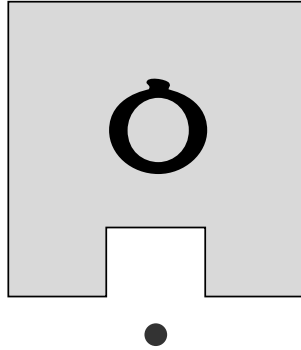
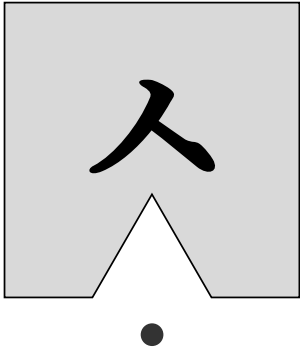

이응

시읏

치읏

지읏

ㅇ

ㅅ

ㅊ

ㅈ

ㅇ

ㅅ

ㅊ

ㅈ

A

한글

[자음 익히기]

ㅅ~ㅎ 익히기 ④

📖 ㅋ~ㅎ을 어떻게 읽는지 찾아 선으로 잇고, 따라 써 보세요.

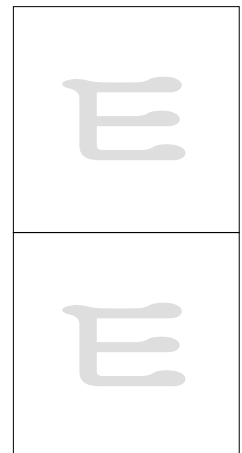
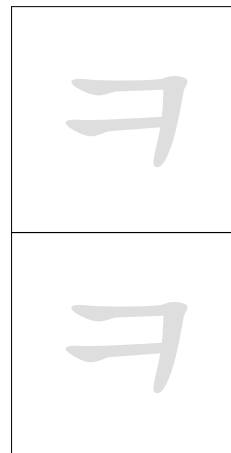
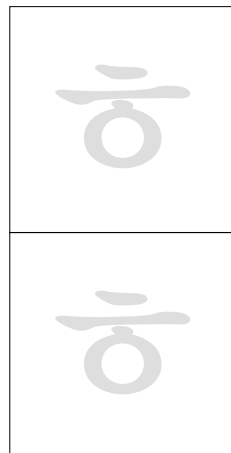
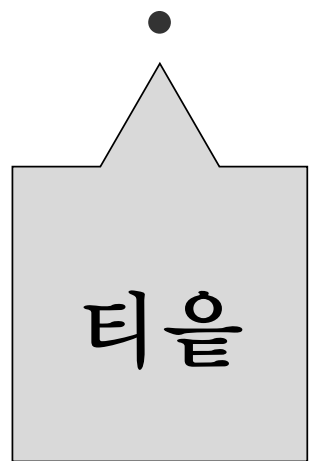
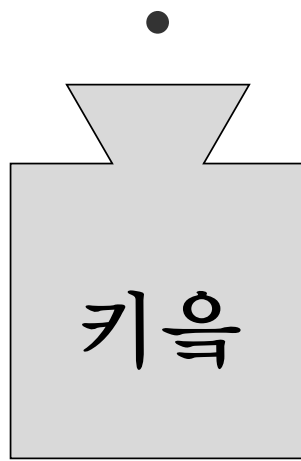
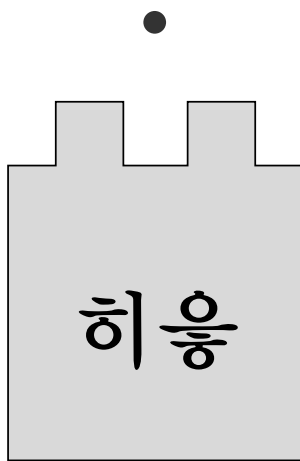
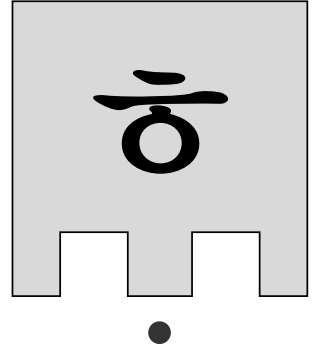
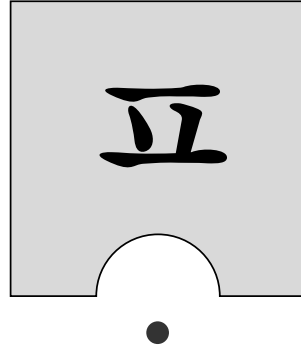
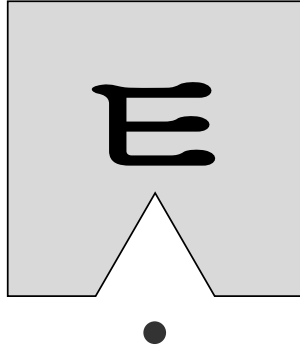
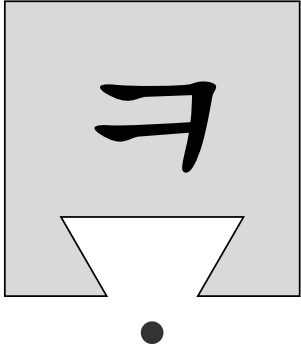

A**한글****[자음 익히기]****ㅅ~ㅎ 익히기 ⑤**

❖ 왼쪽의 낱자가 첫글자에 들어 있는 낱말에 모두 ○를 그려 보세요.

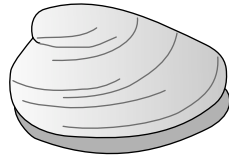

조개



수박

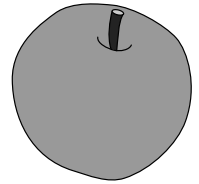

사과

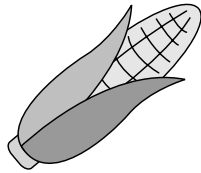
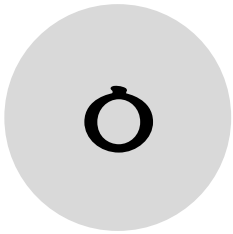

옥수수

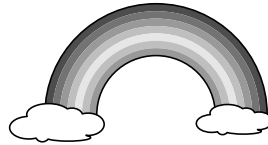

무지개

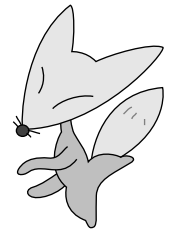

여우

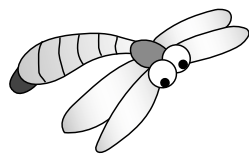

잠자리



주전자

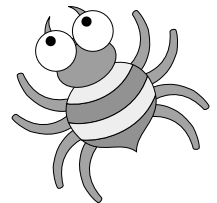

거미

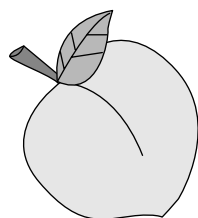

자두

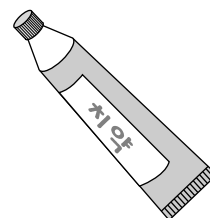

치약

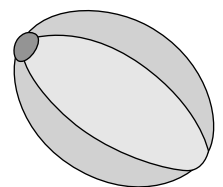

참외

A**한글****[자음 익히기]****ㅅ~ㅎ 익히기 ⑥**

❖ 왼쪽의 낱자가 첫글자에 들어 있는 낱말에 모두 ○를 그려 보세요.

ㅋ

고양이

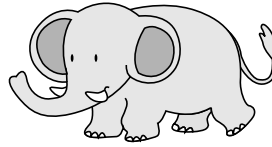

코끼리

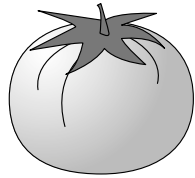

코알라

ㅌ

토마토

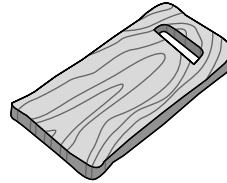

도마

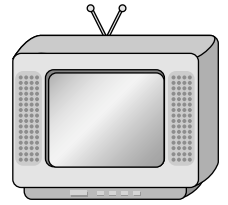

텔레비전

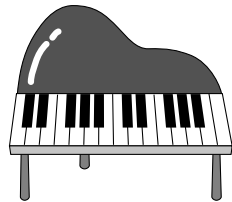
ㅍ

피아노

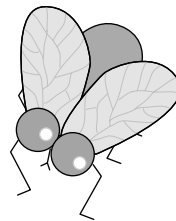

파리

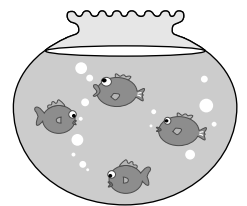

어항

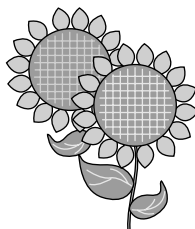
ㅎ

해바라기

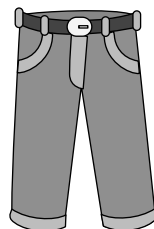

바지

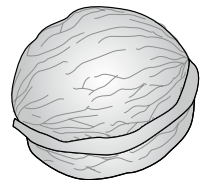

호두

A

한글 [자음 익히기]

ㅅ~ㅎ 익히기 ⑦

◆ <보기>에서 알맞은 낱자를 찾아 써 넣어 낱말을 완성해 보세요.

보기

ㅅ ㅎ ㅈ ㅊ ㅋ ㅌ ㅍ ㅎ

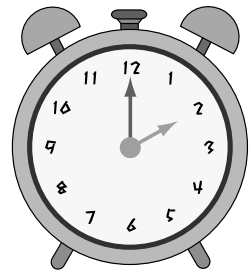
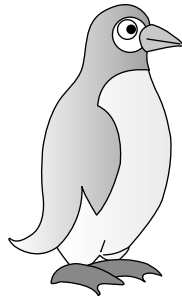
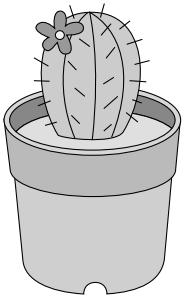

나분

깡권

이계

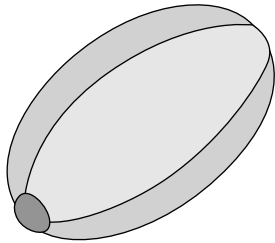

남외

나드

나조

A

한글

[자음 익히기]

ㅅ~ㅎ 익히기 ⑧

◆ <보기>에서 알맞은 낱자를 찾아 써 넣어 낱말을 완성해 보세요.

보기

ㅅ ㅀ ㅈ ㅊ ㅋ ㅌ ㅍ ㅎ

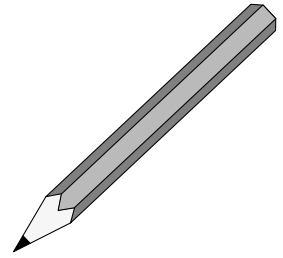
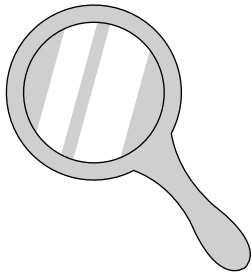

거울

케이크

연필

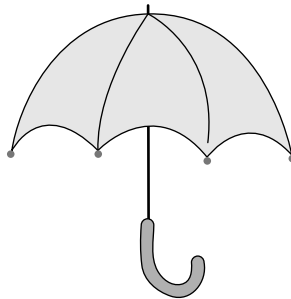
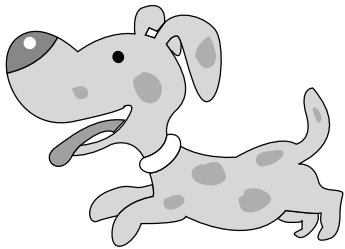

강아지

우산

양초

A

한글 [자음 익히기]

ㄱ~ㅎ 익히기 ①

◆ 그림의 이름에 맞게 알맞은 낱자를 써 보세요.

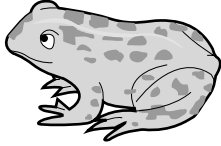

개구 ㅅ

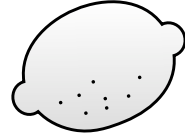

키몬

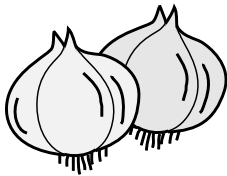

마늘

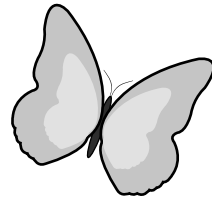

나비



우산



고라

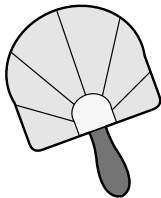

부채

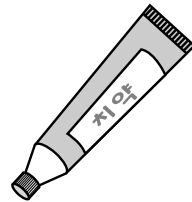

시약

A

한글 [자음 익히기]

ㄱ~ㅎ 익히기 ②

그림의 이름에 맞게 알맞은 낱자를 써 보세요.

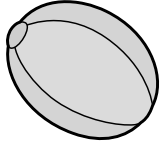

참치



우유



케이크

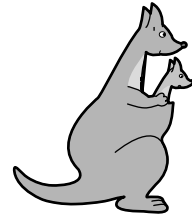

강겨루

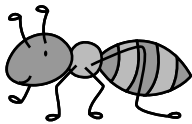

개미

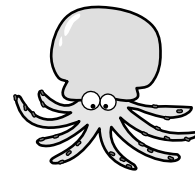

순어

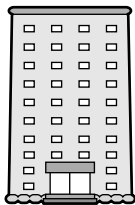

아파



토마토

A

한글 [자음 익히기]

ㄱ~ㅎ 익히기 ③

◆ 그림을 보고, 첫소리를 찾아 ○를 그려 보세요.

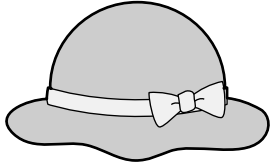

모자

ㅁ

ㅂ

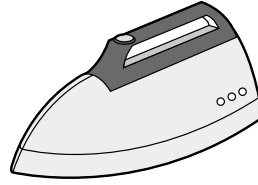

다리미

ㄷ

ㅌ

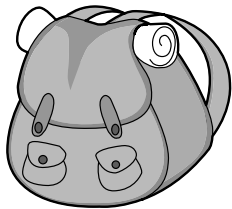

가방

ㄱ

ㄴ

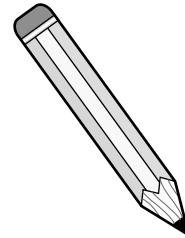

연필

ㅇ

ㅎ

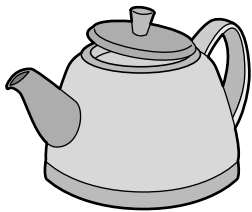

주전자

ㅈ

ㅊ

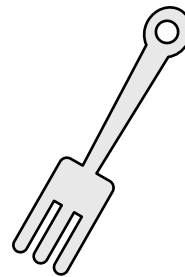

포크

ㅂ

ㅍ



컵

ㄱ

ㅋ

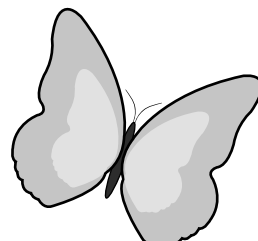

나비

ㄴ

ㄹ

A**한글** [자음 익히기]

ㄱ~ㅎ 익히기 ④

그림을 보고, 끝소리를 찾아 ○를 그려 보세요.

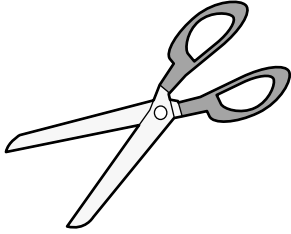

가위

○

○

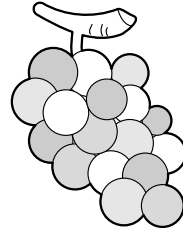

포도

○

○

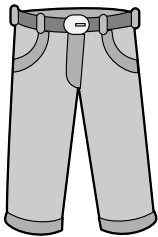

바지

○

○



수박

○

○

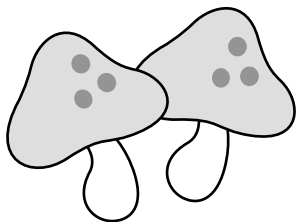

버섯

○

○

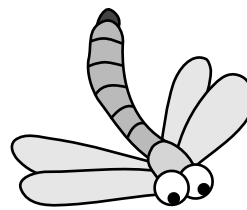

잠자리

○

○

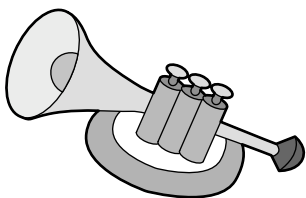

나팔

○

○

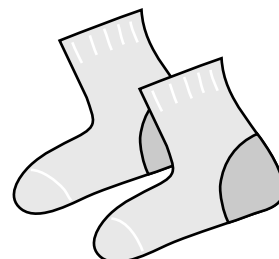

양말

○

○

A

한글 [자음 익히기]

ㄱ~ㅎ 익히기 ⑤

◆ 동물의 이름을 보고, 첫소리를 찾아 □안에 써 보세요.

동물원

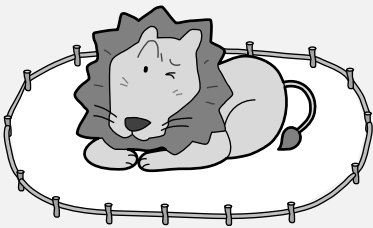

사자

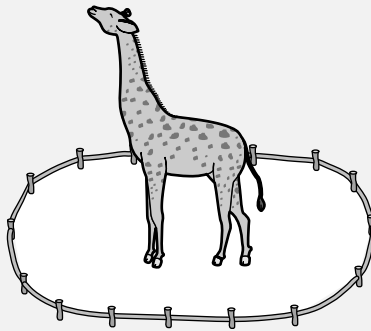

기린

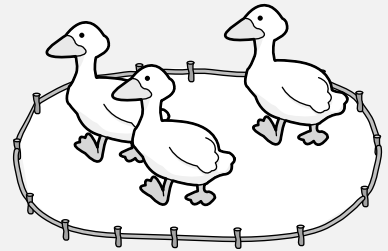

오리

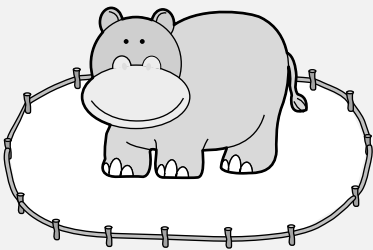

하마

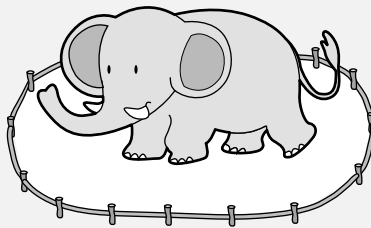

코끼리

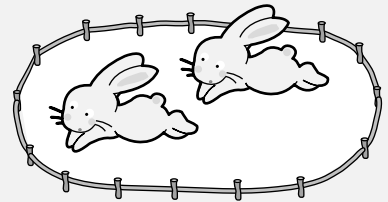

토끼